

WAVECREST CORPORATION

DTS-2070

USER'S GUIDE AND REFERENCE MANUAL

WAVECREST Corporation continually engages in research related to product improvement. New material, production methods, and design refinements are introduced into existing products without notice as a routine expression of that philosophy. For this reason, any current *WAVECREST* product may differ in some respect from its published description but will always equal or exceed the original design specifications unless otherwise stated.

Copyright 1994-2000

WAVECREST CORPORATION
A TECHNOLOGIES COMPANY
7626 GOLDEN TRIANGLE DRIVE
EDEN PRAIRIE, MINNESOTA 55344
(952) 831-0030
(800) 733-7128

www.wavecrest.com

All Rights Reserved

IBM is a registered trademark of International Business Machines, Inc. LaserJet is a registered trademark of Hewlett-Packard Company. Epson is a registered trademark of Epson America, Inc.

This page intentionally left blank.

DTS-2070 User's Guide and Reference Manual

Table of Contents

Preface	Purpose of this Manual	1
	Organization.....	1
Section 1	General Description	
	1-1 Introduction	2
	1-2 Capabilities/Features	6
	1-3 Hardware Description.....	7
	1-3.1 External Interface	7
	1-3.2 Liquid Crystal Display (LCD) Menus	10
	1-3.2-1 Summary of Menu Selections	10
	1-3.3 Modes of Operation.....	13
	1-3.4 Arming.....	14
	1-3.5 Controls	15
	1-4 Performance Specifications	16
Section 2	Operation	
	2.1 INTRODUCTION	17
	Setup, Power-up, and Diagnostics.....	18
	2.1-1 Setup.....	18
	2.1-2 Power-up	18
	2.1-3 Diagnostics	18
	2.2 Control Selection.....	20
	2.2-1 Menu Scroll/Cursor Control (Up/Down/Left/Right).....	20
	2.2-2 Increment/Decrement	20
	2.2-3 Go	21
	2.2-4 Function.....	21
	2.2-5 Pulse Find.....	21
	2.3 Menu Selection.....	22
	Menu #1: Main Function	22
	Menu #2: Channel Voltage References	23
	Menu #3: External Arming Voltage References.....	23
	Menu #4: External Arming	25
	Menu #5: Arming Sequence Selection	25
	Menu #6: Arming Event Setting.....	26
	Menu #7: Voltage Measurement - DC & Strobed	26
	Menu #8: Time Filtering.....	27
	Menu #9: Cable Measurement	28
	Menu #10: Part/Serial Number	28

Menu #11:	Port	29
Menu #12:	Memory - Name/Save/Recall	29
Menu #13:	Printer	30
Menu #14:	Statistics Setting - Size & Format	33
Menu #15:	Pulse Find Peaks.....	33
Menu #16:	Statistics I Min/Max & Samples Taken	33
2.4	Mode Selection	34
2.4-1	Internal Calibration (Labeled INT CAL).....	34
2.4-2	Internal Calibration Optimization.....	34
2.4-3	External Calibration (Labeled EXT CAL).....	35
2.4-4	External Calibration Theory of Operation.....	35
2.4-5	DC Calibration.....	35
2.4-6	AC Calibration.....	36
2.4-7	Calibration Validity Checks.....	36
2.4-8	Burst.....	37
2.4-9	Special Case.....	37
2.4-10	Continuous (Labeled CONT).....	37
2.4-11	Idle	37
2.4-12	DC Calibration Reference Voltages.....	37
2.5	Arming Selections.....	38
2.5-1	Arming Source Selection	38
2.5-2	Automatic Arm (Labeled AUTO).....	38
2.5-3	External Arm (Labeled EXT)	38
2.5-4	Manual Arm (Labeled MAN)	38
2.5-5	Arming Sequence (Enable) Modes	39
2.5-6	Using the Arming Source & Sequence Together.....	40
2.5-7	Ambiguity	42
2.5-8	Gating (Using Arm 2 Input).....	44
2.5-9	Measuring Voltage in Time (Strobing Voltmeter).....	45
2.6	Statistical Calculations - (Sample Size/Set Size/Statistics)	46
2.7	Installation and Maintenance	46
2.7-1	Installation Location	46
2.7-2	Mounting.....	47
2.7-3	Ventilation.....	47
2.7-4	Maintaining Proper Instrument Ground.....	47
2.7-5	Fuse Replacement	47
2.7-6	Preventative Maintenance.....	47
2.7-7	Intended Use of Equipment	47
	Operator's Quick Reference Guide.....	48

Section 3 GPIB Interface

3.1	Summary of DTS Commands	49
3.1-1	System Commands	49
3.1-2	Acquire Commands	50
3.1-3	Calibrate Commands	41
3.1-4	Channel Commands	41
3.1-5	Display Commands	41
3.1-6	Measure Commands	52
3.1-7	Trigger Commands	52
3.1-8	Hardcopy Commands	52
3.2	IEEE-488.1 Bus Commands (Hardware)	53
3.2-1	Common Commands	53
3.3	Root Commands	53

Figures and Tables

Figure 1-1	<i>WAVECREST</i> DTS Time Measurement Instrument	3
Figure 1-2	DTS Block Diagram	4
Figure 1-3	Front Panel	6
Figure 1-4	Rear Panel	7
Figure 1-5	Rising to Rising Time Measurement	11
Figure 2-1	Simplified Diagram of Operating Setup	17
Figure 2-2	Front Panel	19
Figure 2-3	Rear Panel	19
Figure 2-4	Example of Pulse Find when Activated	22
Figure 2-5	Menu Selections	24
Figure 2-6	Arm on Stop and Start	25
Figure 2-7	Band Pass Filter	27
Figure 2-8	Histogram of Samples	32
Figure 2-9	Arm on Stop	39
Figure 2-10	Arm Stop after Start	40
Figure 2-11	External Arm	41
Figure 2-12	External Arm with Delay	41
Figure 2-13	Example 1 - Proper Readings	42
Figure 2-14	Example 2 - Arming Signal Delayed	43
Figure 2-15	Example 3 - Positive & Negative Readings	44
Figure 2-16	Gating Mode	44
Figure 2-17	Delayed Scan for Measuring Voltage in Time	45
Table 1-1	Symbol Description Table	19
Table 2-2	Operator's Quick Reference Table	48

This page intentionally left blank.

PREFACE

PURPOSE OF THIS MANUAL

This manual has been prepared to help the user achieve maximum results from the DTS-2070 in the shortest possible time. The manual's physical size, format, and content is designed to make it easy to use for the new user as well as the established user.

ORGANIZATION

The manual is organized so that the information needed can be found easily and in the fastest possible time. Content is divided into sections, each dealing with one phase of the instrument's operation.

The following is a brief description of the information contained in each section. For quick reference to specific information, refer to the Table of Contents.

Section I — General Description: Introduces you to the DTS-2070. Capabilities and features are described. All hardware relating to the use of the DTS-2070 is described. A complete table of the DTS-2070 performances can be found at the end of this section.

Section II — Operation: This section provides step-by-step procedures for all phases of operation, including power-up and diagnostics, calibration and mode selection, triggering, controls, and selecting/using menus. Diagrams outlining the sequence of operation provide detailed steps for getting the most from your DTS-2070 and using it to its full potential. Also included is an Operator's Quick-Reference Table that conveniently allows at-a-glance referencing for controls and indicators.

Section III — IEEE-488 Interface: Includes various parameters, value, and codes necessary for implementing remote control of the DTS-2070 via the IEEE-488 Interface.

SECTION I. GENERAL DESCRIPTION

This section contains an overview and general introduction to the DTS-2070 Digital Time Scope. It also presents its capabilities, features, and a brief description of the hardware included in the instrument. Performance Specifications are in of this section.

1-1 INTRODUCTION

The Wave 2070 Series Digital Time Scope (DTS) is designed for applications where timing accuracies are critical. The DTS provides direct, real-time measurements without the errors associated with sampling and transforming of data while waiting for a waveform to be displayed. The result is a precision instrument capable of measuring time between two events with a resolution of 800 femtosecond and single-shot measurement accuracy of $\hat{\uparrow}$ 30 picosecond (ps). Refer to Figure 1-1.

The DTS represents a dramatic departure from the traditional digital sampling oscilloscope (DSO) approach to critical timing functions. The DSO approach takes a time frame and then measures the number of events occurring within that time frame to arrive at a figure for elapsed time between each event. The DTS approaches the measurement algorithm as absolute; time between any two events is actual, measurable, and workably quantifiable.

The Wave DTS is intended for AC characterization, with the added benefit of N.I.S.T. traceability, in applications ranging from ATE test head deskew, bench top device test and computer clock distribution. In addition, the DTS is well suited for scientific and engineering applications which require timing accuracies and resolution more precise than currently available instruments can provide. The DTS achieves greater accuracy with fewer readings and less time than digital scopes or other types of time domain measurement devices.

Measurement accuracy and linearity of the DTS-2070 is generated over the long-term due to the built-in calibration which can be introduced by the user at any time.

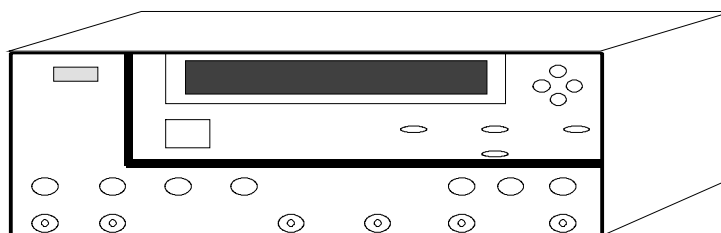

Figure 1-1. WAVE DTS-2070 Time Measurement Instrument

HOW THE DTS WORKS

The key to understanding the Wave DTS line of products is understanding arming versus triggering.

Oscilloscopes have triggered time bases that require triggering to start the time base sweep so they can display events with respect to linear time. The DTS is not triggered but Armed or Enabled to make a measurement of the next event that occurs on the input channels.

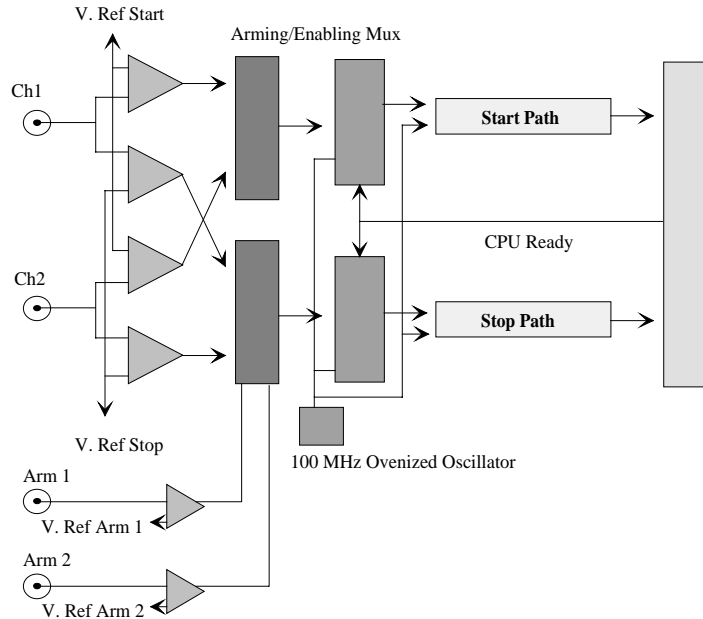

Figure 1-2. DTS-2070 Block Diagram

Figure 1-2 shows a simplified block diagram of the DTS, Digital Time Scope. The inputs of the DTS feed dual comparators on each channel 50Ω to ground. This enables the DTS to measure events such as Period, Pulse Width and Rise/Fall time on a single channel in One-Shot mode. TPD is measured using both channels.

Voltage Reference Start (V.Ref. Start) and Voltage Reference Stop (V.Ref. Stop) set the threshold trip points for the comparator inputs. As the diagram shows, there is a Start and Stop reference voltage on each channel.

“Auto arming” enables the DTS to asynchronously or randomly measure time events, where as, selecting an external arming mode option enables the DTS to synchronize with the event to be measured much like an oscilloscope does when it is triggered. Understand that “Arming” the DTS is not the same as triggering an oscilloscope, just similar.

The External arming inputs go to logic circuits within the DTS and, in conjunction with the “Enable Modes”, select whether the DTS is to be synchronous or asynchronous with respect to the signal to be measured.

The last signal that is of importance is the “CPU ready” signal generated whenever the CPU is ready to process another measurement. This time duration is program controlled so that the measurement or “Burst” rate can be varied.

Hierarchy of making a time interval measurement

All of the time interval measurements made with the DTS-2070 follow a simple 4 step progression; Arm, Enable, Function and Execute. The user asks the following questions before executing a measurement:

1. What Arming source is required to make the measurement?
2. What Function is being measured?
3. What Enable mode is required to make the measurement?
4. Execute time interval measurement.

Whenever a time interval measurement is made, all four steps are executed. To make using the DTS simple and repeatable, all four steps are defaulted for each measurement function of the instrument. These defaults can be changed by the user as desired.

DTS Default Settings

Function	Trig %	Channel	Arm Source	Arming Sequence	Start Count	Stop Count
TPD++	50-50	1-2	Auto	Arm on Stop	001	001
TPD--	50-50	1-2	Auto	Arm on Stop	001	001
TPD+-	50-50	1-2	Auto	Arm on Stop	001	001
TPD-+	50-50	1-2	Auto	Arm on Stop	001	001
TT+	10-90	1	Auto	Arm on Stop	001	001
TT-	90-10	1	Auto	Arm on Stop	001	001
PW+	50-50	1	Auto	Arm on Stop	001	001
PW-	50-50	1	Auto	Arm on Stop	001	001
Period	50-50	1	Auto	Arm on Stop	001	002
Frequency	50-50	1	Auto	Arm on Stop	001	256

In addition to the default settings shown above, all of the channel Voltage References are set to 0.0000 volts unless changed by the execution of a ‘PULSE FIND’ or set externally by the user. The PULSE FIND command will set the reference voltages for each channel based on the TRIGGER percent indicated in Menu 7.

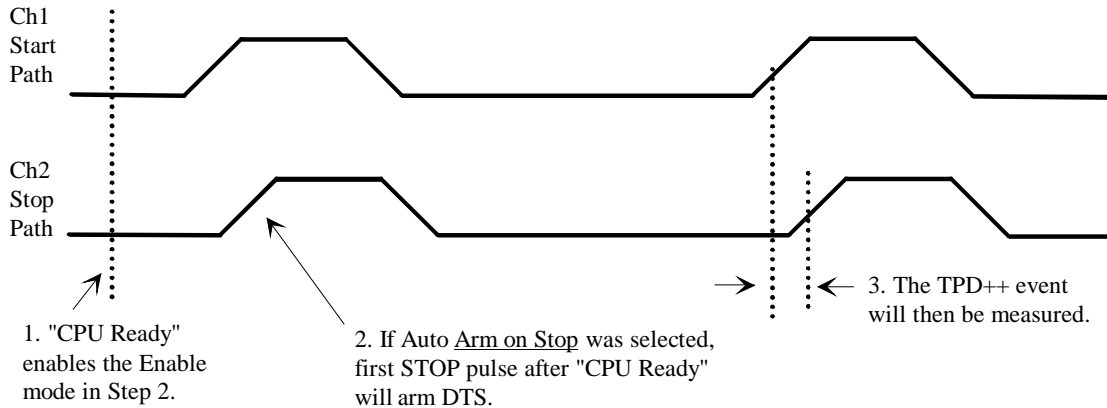

Figure 1-3. Rising to Rising Time Measurement

In Figure 1-3 a measurement is taken from the rising edge of Channel 1 to the rising edge of Channel 2. The instrument is set up for an arming source of Auto and an arming sequence of the Stop path (commonly stated as ‘Auto on Stop’).

The sequence of events that will happen in Figure 1-3 are:

1. The DTS signal ‘CPU ready’ provides a pre-arm.
2. The first (1) rising edge on Ch1, stop path, will arm the instrument.
3. The next rising to rising measurement between Ch1 and Ch2 will be taken.

If a sample size of 1000 was selected, then the above step will be repeated 999 more times.

The results of all 1000 one-shot measurements are stored in DTS memory and statistically analyzed to display the AVERAGE, \pm RANGE and RMS JITTER. The \pm RANGE is the min/max spread of the 1000 measurements. The RMS JITTER is the true statistical standard deviation for the 1000 measurements and represents the RMS jitter in a gaussian distribution. The AVERAGE is the center of the distribution.

The instrument also has the ability to measure the voltage in time (strobed) with a resolution as fine as 10 ps. This can be used to help the user determine where to set the reference voltages. With the help of a host computer, the complete waveform can be graphically displayed.

The instrument also has the ability to Gate the arming of the instrument. The GATING mode is useful if the device to be tested has a “ready or lock” signal such as when a PLL is locked onto some serial pattern. For instance the user may want to only measure the period when the PLL is locked and the data is high and measure again when the PLL is not locked while the data is high to see the difference in frequency and jitter.

1-2 CAPABILITIES/FEATURES

The DTS capabilities and features include:

- Capability of measuring several different characteristics of an electrical pulse. These are:
 - Propagation Delay (TPD++, TPD--, TPD+-, and TPD-+)
 - Rise/Fall Time (TT+, TT-)
 - Period/Pulse Width/Frequency (PW+, PW-, PER, FREQ)
 - Cable Measurement
 - Strobings volt meter - to digitize input waveforms
 - 16 bit DVM on each channel
- Can take one measurement with a single-shot accuracy of ± 30 ps or as many as 1,000,000 readings and give statistical data output with an accuracy of ± 10 ps.
- Two different operational modes and three different triggering capabilities available to the user.
- Has both an internal and external AC and DC calibration modes.
- Front panel incorporates a two-line, 40-character liquid crystal display (LCD) for access to a complete range of menus for the user.
- Input voltage levels that can be set for rising or falling signals from $\hat{1}$ 1.1 volts in 0.15 mV increments. Minimum pulse amplitude of only 50 mV peak to peak is required.
- A PULSE FINDER capability that locates the signals and automatically sets voltage inputs required for measurements. Selectable for find either peaks or flat spot.
- System capability of taking $>15,000$ readings per second and handling pulse trains up to a frequency of 650 MHz.
- IEEE-488 Interface that allows for standardized integration into OEM products, giving the user remote capabilities with selectable addressing.
- Features summarized:
 - 800 femtosecond resolution
 - ± 30 ps single shot accuracy
 - ± 10 ps average accuracy
 - 15,000 readings/sec. - 30,000/sec with “HiPer” option
 - Time measured from $\hat{1}$ 2.5 sec.
 - Independently programmed voltage thresholds $\hat{1}$ 1.1V
 - Auto calibration

- IEEE-488 interface
- N.I.S.T. Traceable
- Strobings voltmeter
- 16 bit DVM to measure voltage on channels
- Digital filters to select data to measure

1-3 **HARDWARE DESCRIPTION**

The DTS incorporates a three-card timing measurement subsystem, a single-card Central Processing Unit, comparator card, front panel for operator control of the instrument, ovenized crystal oscillator, power supplies, and an IEEE-488 interface. Input signals to the DTS-2070 are provided by SMA connectors.

The front panel (Figure 1-4) provides the means for controlling, monitoring, and communicating with all time measurement functions of the DTS.

1-3.1 **EXTERNAL INTERFACE**

Four external inputs and 2 signal outputs are routed through SMA connectors on the front panel directly into the DTS-2070. The six SMA connections on the front panel are:

- | | |
|-----------------------------|---|
| CH1 | Used for a START event input pulse for TPD measurements. Inputs START and STOP event pulses for all other measurement modes. |
| CH2 | Used for a STOP event input pulse for TPD measurements. Inputs STOP and START event pulses for all other measurement modes. |
| External Cal 1/Cal 2 | Used for AC Deskew and DC offset and gain of DTS Inputs and for Coax Cable Delay measurement. |
| Ext. Arm1/ Arm2 | Used as input for the External Arm, which starts the measurement of the next pulse seen on the CH1 and CH2 connectors when Ext. Arm mode has been selected. |

The rear panel (Figure 1-5) contains five additional interfaces:

AC Power/Line Filter/Fuse	Used for the incoming AC power cord. When the power switch is ON, the crystal oven is ON. Power to the remainder of the system is controlled by the STANDBY power switch on the front panel. The AC power may be either 110VAC $\pm 20v$, or 220VAC $\pm 40v$, single phase. The DTS typically draws 1.8 Amps, and is fused with two, 5 Amp, slo-blow, 5x20mm fuses (Wavecrest part number 400067-06).
IEEE-488 Connector	Permits remote operation of the DTS. Section 3 contains specific information and instructions concerning IEEE-488 protocol.
External 100 MHz Signal SMA	Provides a $\pm 100mV$ 100MHz signal to check the accuracy of the internal 100 MHz Frequency Standard.
RS232/SCSI	Provide for option connections.
RESET	A pushbutton is provided to reset the system. The power up diagnostics are not performed during a reset.

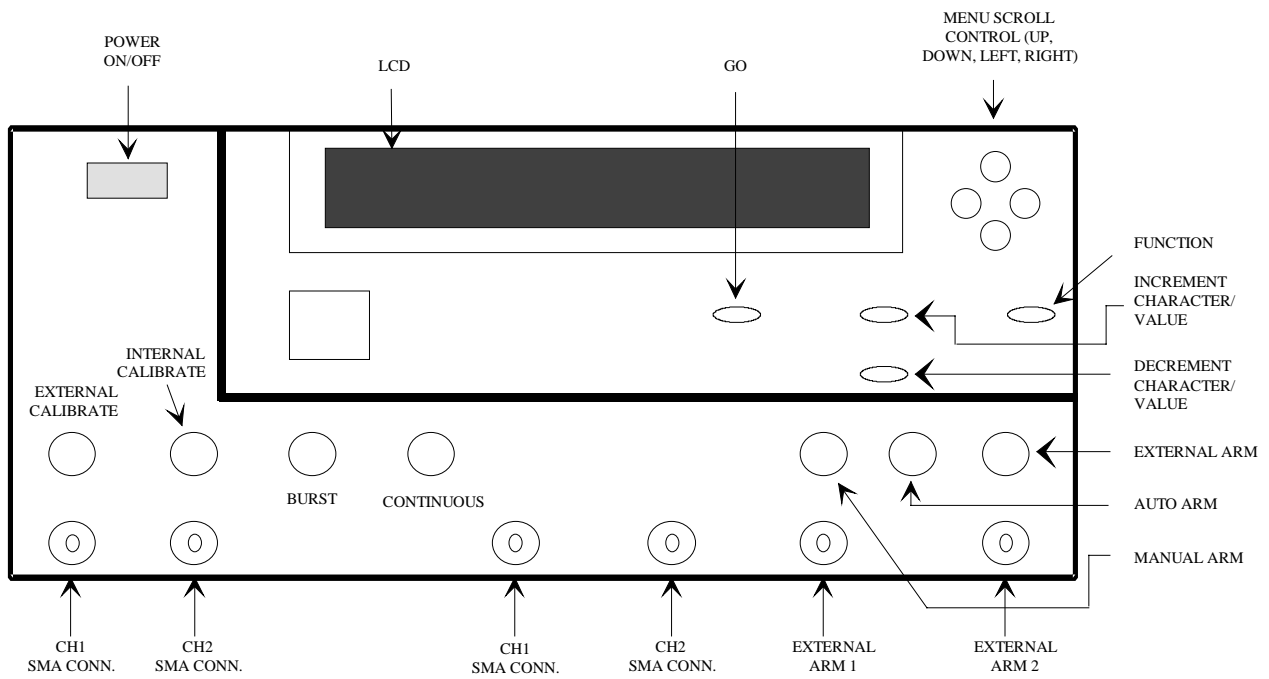

Figure 1-4. Front Panel

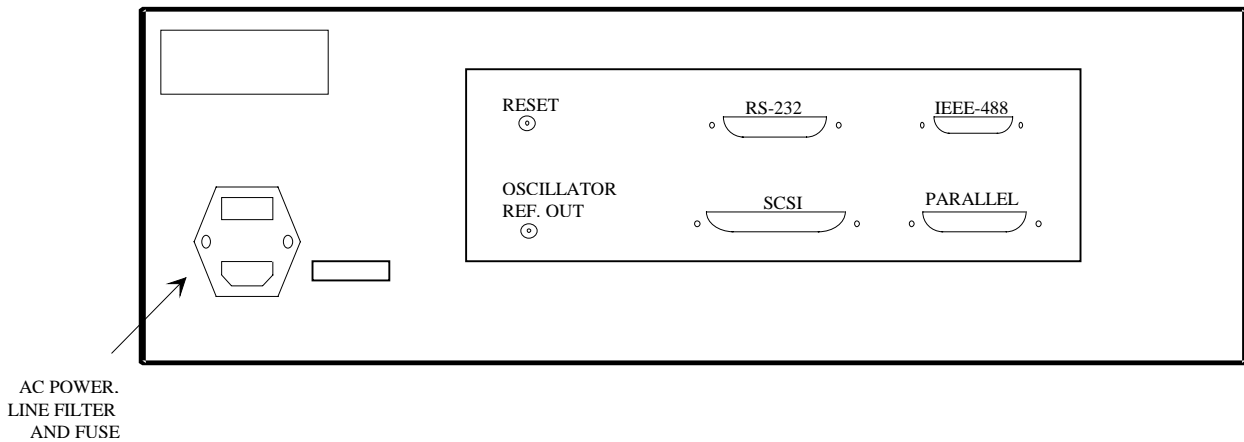

Figure 1-5. Rear Panel

1-3.2 LIQUID CRYSTAL DISPLAY (LCD) MENUS

A two-line 40-character liquid crystal display (LCD), located on the front panel of the instrument, provides the user access to a variety of menus or screens. With the menus, the user can scroll to the appropriate menu to store information, view sampling information, or define program-specific measurement parameters as required by the customer's application.

The LCD (display) is also used to alert the operator, prompt action where necessary, and display system status.

1-3.2-1 SUMMARY OF MENU SELECTIONS

The user has the option of selecting any one of 15 possible menu screens. These menus allow the operator to select features or parameters for I/O addressing, memory storage, printing, statistics, pulse find AC and DC measurement, filtering, and cable measurement. Figure 1-6 graphically illustrates the menus.

Port Addresses/Pulse Find Mode/Clear

Sets GPIB and SCSI addresses.
Select Pulse Finder modes of PEAK or FLAT.
System Clear.

Memory

Provides for the saving, recalling and naming of ten (10) save memories.

Printer

Provides the selection and control of printing.

Statistics Settings

Sets the sample and sets size and sets the unit the statistics will be displayed in.

Pulse Finder Peaks

Displays the minimum and maximum peak voltages found with a pulse finder.

Statistics I

Displays the sample size and samples completed.
Displays the minimum and maximum readings of a time measurement.

Main Function (Default Menu)

Provides the selection of specific functions which define and sets up parameters associated with a function.

Provides the selection of a percentage of peak that the start/stop references will be set to during a pulse find.

Provides the selection of the input channel to be used during a measurement.

Displays the average, range and jitter after a measurement is completed.

Time Measurement Parameters

Start/Stop Reference Voltages - displays the start and stop reference voltage found during a pulse find. Provides an input of user defined reference voltages. The information for each reference voltage is the edge direction, polarity and level.

External Arming Reference Voltage - Displays the external arming inputs for Arm 1 and Arm 2 found during a pulse find. Provides an input of user defined arming reference voltages. The information for each reference voltage is the edge direction, polarity and level. Provide the turning on/off of the Gating feature.

Arm on Nth Event - Provides the input of start and stop counts which will define the time of the respective arming of start and stop.

Voltage Measurement Parameters

Provide the selection of the type of dc measurement that will be taken when a function button is pressed while in this menu. The three types are DC, Strobed by Arm 1 and Strobed by Arm 2.

Provides the selection of input channel for measuring a voltage.

Provides for input of a delay, from arming, for strobing a voltage measurement.

Displays the voltage level of a dc or strobed voltage measurement.

Time Filtering

Provides an input of filtering limits, minimum and maximum and turning the filtering feature on or off.

Cable Measurement

Displays the average reading after a cable measurement and turning the cable measurement on or off.

Figure 1-6. Menu Selection

1-3.3 MODES OF OPERATION

The DTS has five modes of operations that are selectable by the user. Four modes are controlled by pushbutton switches located on the front panel. At power On, the DTS is placed in the fifth mode, Idle, which is a *wait* state. These modes are:

<u>Title</u>	<u>Function</u>
External Calibration	Used for External Calibration/Deskew of the CH1/CH2 inputs. Automatically measures and corrects for input variations of the CH1/CH2 comparators, then stores these values in memory to be used to correct all future measurements. Also used to perform a DC gain and offset calibrations of the test probes.
Internal Calibration	The DTS automatically calibrates itself internally to a N.I.S.T. traceable 100 MHz ovenized crystal oscillator in approximately 300 seconds.
Burst	The DTS will complete the number of readings equal to the sample size selected and then stop. When the sample size is reached, the DTS displays the computed data.
Continuous	Continuously measures pulses in this mode. Once the number of pulses measured equals the sample size, the newly computed data is displayed and the process begins again to collect a new series of measurements equal to the sample size.
Idle	The DTS is in the wait state if none of the other modes have been selected. Power On or completion of Burst mode places the DTS into Idle mode.

1-3.4 ARMING

The DTS has three arming capabilities that are selectable by the user. These three are selected by three pushbuttons located on the front panel. The arming capabilities are:

<u>Title</u>	<u>Function</u>
Automatic	This allows automatic measurement to the sample size, based on the edges of the Start/Stop pulses. If Burst mode is selected, no further pulses are accepted after the sample size is achieved; if Continuous is selected, a new series of measurements will begin after the sample size is achieved.
External	Allows external signal source to arm the DTS for measurements. Once armed, the DTS measures the next pulse presented. If Burst mode is selected, no further pulses are accepted after sample size is achieved; if Continuous is selected, a new series of measurements will begin after the sample size is achieved.
Manual	Activates the system to take measurements when the GO button is pushed. Once armed, the DTS measures the next pulse presented. Every time the GO button is pushed, the sample size is incremented. The statistics are not updated until the sample size has been achieved. If Burst mode is selected, no further pulses are accepted after sample size is achieved; if Continuous is selected, a new series of measurements will begin after the sample size is achieved.

1-3.5 CONTROLS

The DTS has five control functions that are available for the user. These five functions are located on the front panel and are pushbutton switches (refer back to Figure 1-4). Two of the functions have multiple pushbuttons. The five control functions are:

<u>Title</u>	<u>Function</u>																
Menu Scroll	Allows the user to scroll from menu to menu and field to field inside a menu. There are four pushbuttons in this function: UP, DOWN, LEFT and RIGHT.																
Increment/Decrement	Allows the user to increase or decrease values in selected fields or change options, both contained within the menus. There are two pushbuttons in this function: INCREMENT or DECREMENT.																
Go	Allows the user to restart the DTS after certain modes that require external action are taken by the user. The DTS always gives a prompt on the menu for the GO function.																
Function	<p>The FUNCTION push button is used for different functions for the different menus.</p> <p>Menu Function:</p> <table><tbody><tr><td>Memory</td><td>Initiate RECALL/SAVE.</td></tr><tr><td>Statistics I</td><td>Calculates unfiltered statistics.</td></tr><tr><td>Printer</td><td>Initiate a print.</td></tr><tr><td>Pulse Finder Peak</td><td>Initiate a pulse find.</td></tr><tr><td>Main Function</td><td>Initiate a pulse find.</td></tr><tr><td>Time Measurement #8</td><td>Initiate a pulse find.</td></tr><tr><td>Time Measurement #9</td><td>Initiate a pulse find.</td></tr><tr><td>Voltage Measurement</td><td>Initiate DC or strobed measurement.</td></tr></tbody></table>	Memory	Initiate RECALL/SAVE.	Statistics I	Calculates unfiltered statistics.	Printer	Initiate a print.	Pulse Finder Peak	Initiate a pulse find.	Main Function	Initiate a pulse find.	Time Measurement #8	Initiate a pulse find.	Time Measurement #9	Initiate a pulse find.	Voltage Measurement	Initiate DC or strobed measurement.
Memory	Initiate RECALL/SAVE.																
Statistics I	Calculates unfiltered statistics.																
Printer	Initiate a print.																
Pulse Finder Peak	Initiate a pulse find.																
Main Function	Initiate a pulse find.																
Time Measurement #8	Initiate a pulse find.																
Time Measurement #9	Initiate a pulse find.																
Voltage Measurement	Initiate DC or strobed measurement.																
Power Standby	<p>Toggles power On or Off the DTS. When power is On, the LCD background is illuminated and remains lit as long as power is applied to the system.</p> <p>The crystal oven is energized whenever the power cord is connected to the AC power source and the main power switch is on. The front panel toggle switch controls the power to other DTS circuits.</p>																

1-4 PERFORMANCE SPECIFICATION

Timing Measurement Performance

Single Shot Accuracy:	± 30 picosecond (ps) $\pm (1 \times 10^{-7})^*$
Accuracy with Averaging:	± 10 ps $\pm (1 \times 10^{-7})$
Repeatability:	± 2.5 ps typical @ sample size > 1,000
Resolution:	800 femtosecond (fs) internal, 1 fs displayed
Range:	0 to 2.5 seconds
Measurement Rate:	>15,000 readings/second maximum
Jitter:	<10 ps RMS

*After internal/external calibration.

Input Signal Characteristics

Input Threshold Resolution:	\hat{u} 1.1V, .15mV
Sensitivity:	>30mV (peak to peak)
Impedance:	50 Ohm
Frequency:	650 megahertz (MHz)
Minimum Pulse Width:	0.8 nanoseconds (ns)
Connectors:	SMA type

Arming Functions

Automatic:	Auto arms, starts and stops on incoming edges
Manual:	Arms inputs with GO pushbuttons to accept next incoming edge
External:	
Input threshold	\hat{u} 1.1V
Resolution	0.15mV
Sensitivity	>30mV (peak to peak)
Impedance	50 Ohm
Connectors	SMA type

Statistical Functions

Average:	Average of n readings
Jitter RMS:	Distribution of n readings Displays "0" in single shot mode
Minimum and Maximum Reading/Range:	The difference between minimum and maximum measurement taken for last burst

2-Line LCD Display with Menu

Channel 1:	Voltage threshold; rising/falling edge
Channel 2:	Voltage threshold; rising/falling edge
Pulse Finder:	Automatic selection, 50%, 10-90%, 20-80%, points of input signal
Arm:	Voltage threshold
Force:	Auto Trig. on Start; Auto Trig. on Stop; Enable Stop after Start; Enable Start after Stop
Filters:	Band pass filter (time window)
Presets:	Ten (10) memories
Set number of samples:	1 to 1,000,000
IEEE-488 and SCSI:	Select address
Choice of Display Units:	ps, ns, us, ms, s, auto scale, fs
Cable Length Measurement:	Time delay

Optional Modes

Burst:	Perform n measurements, halt and update display
Continuous:	Continuously make n measurements, update display after each n reading

Calibration Modes

Internal:	Internal calibration to self contained N.I.S.T. traceable standard, in 300 second
External:	Deskew/calibrate inputs

Timebase

High stability, low phase noise, ovenized, N.I.S.T. traceable, crystal oscillator.	
Frequency:	100 MHz
Aging/day:	5×10^{-10} seconds
Aging short term:	5×10^{-11} seconds
Accuracy:	1×10^{-7} seconds

IEEE-488 Interface

All front panel functions (and more) can be programmed.

Power Requirements

Voltage:	100-125 VAC; 216-260 VAC
Frequency:	47-63 Hz
Power:	Less than 300 W
Fuses:	4A/125V, slo-blow, 5x20mm

Temperature Requirements

Temperature:	Ambient room 15C to 35C
Temperature range for Calibration:	Calibration Temperature \pm 5C

Size/Weight

Size:	56cm(L) x 49cm(W) x 19cm(H)
Weight:	50 lb

All specifications are subject to change without prior notice on liability to existing owners of this equipment.

Table 1-1 Symbol Description Table

Specific cautionary or warning information may appear on the product or in this manual, where they apply. The following is a summary of their meanings.

CAUTION

This statement identifies conditions that can result in damage to the DTS or property

WARNING

This statement identifies conditions that can result in personal injury or loss of life.



This symbol indicates applicable cautionary information is noted.

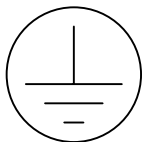

Protective earth ground.

SECTION II OPERATION

This section leads you through the sequence of steps for using the DTS-2070. Flow diagrams and figures supplement the textual descriptions. The diagrams have been designed as an aid for repeated referencing when quick recall of a particular step is required.

2-1 INTRODUCTION

Using the instrument is not complicated, and follows a logical flow of events with each power-up. Also, high-resolution accuracy depends on using good interface techniques. It is necessary to follow standard microwave techniques for 50 Ohm environments.

Figure 2-1 is a simplified diagram of an operating setup and will be used as a reference to clarify statements in the operation. For example, the device under test (DUT) output connection would be defined as the connection point of the cable at the DUT, not at the DTS.

For best results, all cabling must be double-shielded 50 Ohm coaxial. The DTS does accept passive or active probe inputs with a 50 Ohm environment. Ideally for signal integrity, all external signals should terminate to 50 Ohm environment at the SMA connectors. The 50 Ohm input is terminated to ground.

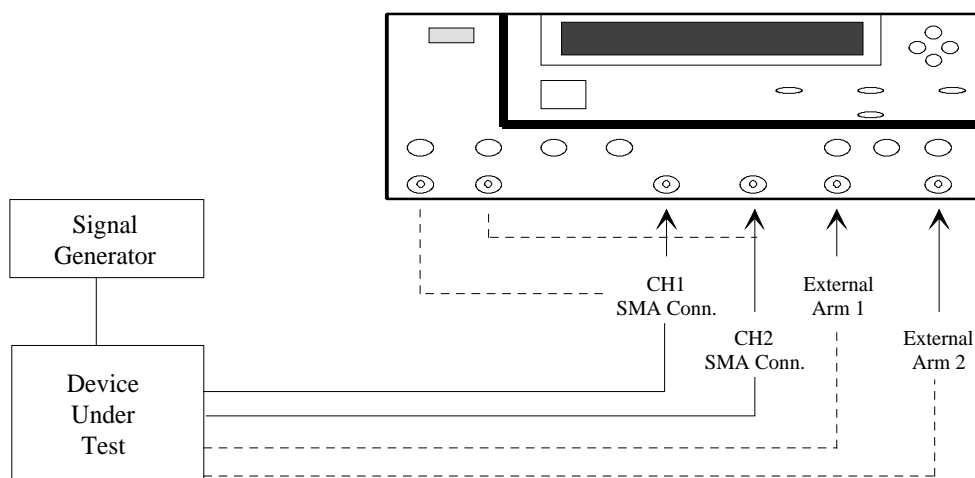

Figure 2-1. Simplified Diagram of Operating Setup

The normal operating procedure required from power-up through the use of the instrument's full capabilities can conveniently be divided into six parts:

2-2 Set-up, Power-Up, and Diagnostics

2-3 Control Selection

2-4 Menu Selection

2-5 Mode Selection

2-6 Arming Selection

2-7 Calculations

Refer to Figures 2-2 and 2-3 for location and identification of pushbuttons, indicators, connections or other components specified in the operating procedures contained in this section.

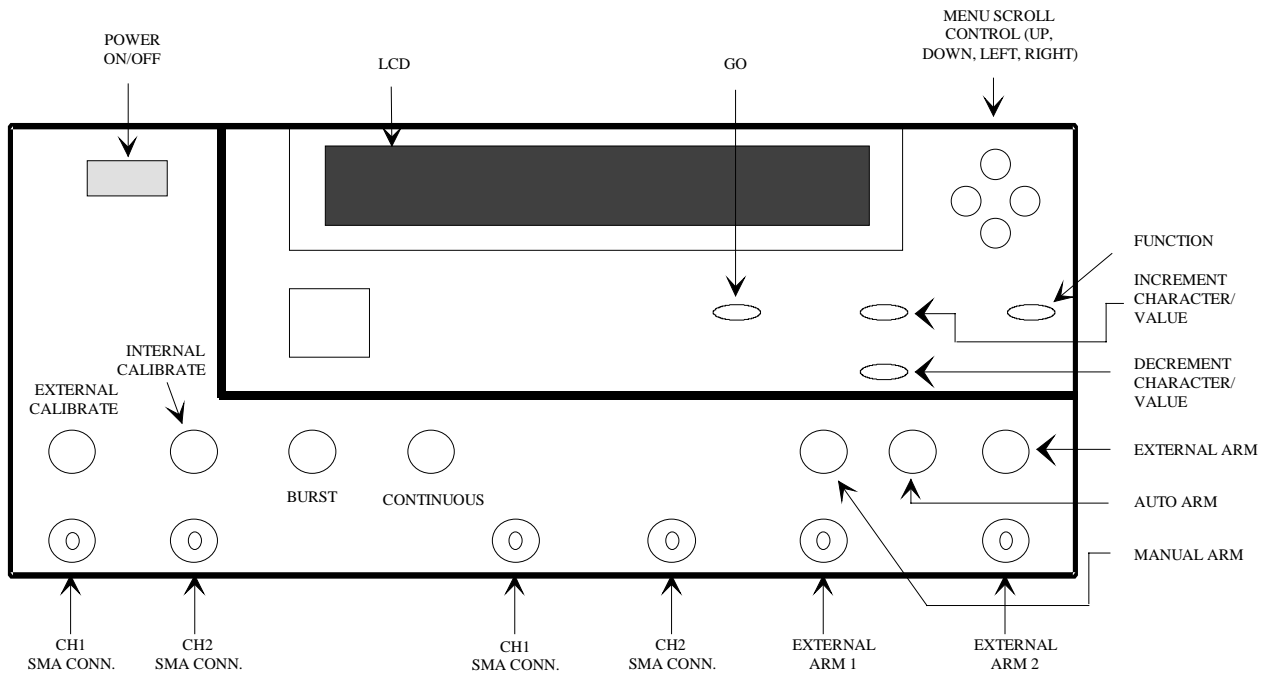

Figure 2-2. Front Panel

2-2 SETUP, POWER-UP, AND DIAGNOSTICS

This subsection covers the setup, power-up, and diagnostics for the DTS-2070. Also covered are the functions of the IEEE-488 connector and the AC power switch.

2-2.1 SETUP

Plug the unit into a compatible AC power source. Refer to page 1-18 for power requirements and Figure 2-3 below for location of AC power connection on the back of the DTS. Refer to Section 2-8 for detailed instructions on the proper installation, ventilation, fuse replacement and use of the DTS unit. A spare fuse is provided inside the fuse compartment.

2-2.2 IEEE-488

If IEEE-488 GPIB is used, plug the IEEE-488 cable into the connector at the rear of the unit. Refer to Section III for information and instructions on the IEEE-488 protocol.

2-2.3 AC POWER SWITCH

The main AC power switch, located on the rear panel, controls power to the 100 MHz crystal oven separate from the remainder of the device power. If the main AC power switch is ON, the oven is always ON. The standby switch on the front panel must also be ON to provide power to the rest of the device.

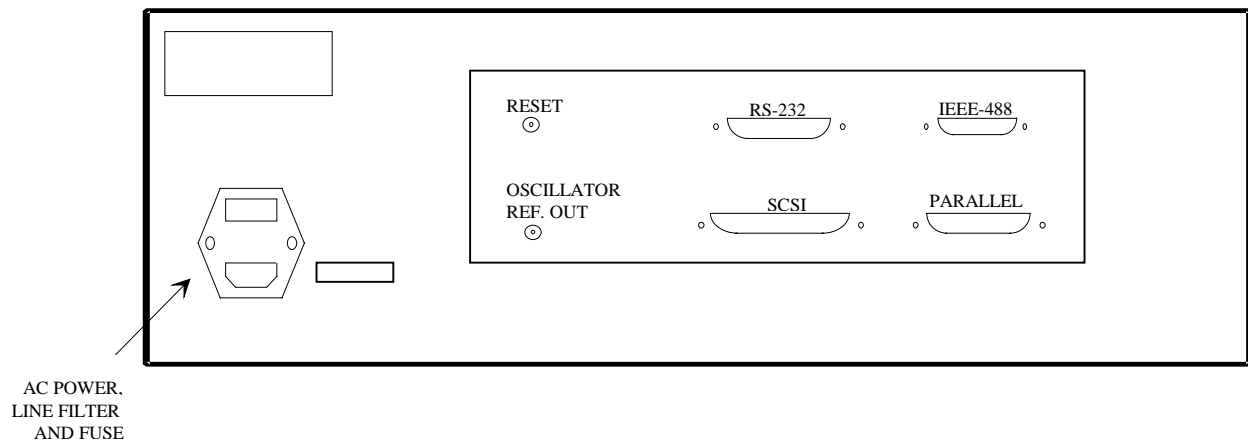

Figure 2-3. Rear Panel

2-2.4 POWER-UP

Push the POWER ON/OFF switch on the front panel. The LCD (display) should illuminate.

IMPORTANT: If DTS is powered Off for some reason, wait for 5 sec. before powering back up. This allows the power supplies to properly discharge and avoid potential damage.

2-2.5 DIAGNOSTICS

The first in a series of self-diagnostics will begin with the CPU and Front Panel (refer to Figure 2-4). This test is comprised of two parts, performed simultaneously:

Test #1: CPU Test

During the first part of this test, the main CPU board performs a self-test board-level diagnostics. After the CPU self-diagnostics pass, the CPU then performs a diagnostic test to confirm communications with the Front Panel.

Test #2: Front Panel Test

During the Front Panel test, the front panel microprocessor board performs self-test board-level diagnostics. After all tests for the CPU and front panel pass, the CPU initiates the next series of tests as follow:

<u>Test #</u>	<u>Name</u>	<u>Description</u>
3	TMI3C	Test calibration circuits
4	TMI1	Test Start/Stop channel timing
5	TMI2	Test logic control circuits
6	TMI3I	Test channel interface circuits
7	COMP	Test comparator circuits

All of the above tests take less than 5 sec. to run. Upon successful completion of these tests, the DTS will display the Default menu, which is the Main Function (#7) menu.

IMPORTANT: The DTS is a precision instrument. The unit operates best after a warm-up period. Wait a minimum of 30 minutes for warm-up. Acceptable readings can be obtained after a 30-minute warm-up and calibration.

Figure 2-4. Power-Up and Diagnostics Flow Diagram

2-3 CONTROL SELECTION

The Control Selection consists of four groups of pushbuttons that allows the user to control the DTS from the front panel. These four pushbuttons are:

**Menu Scroll/Cursor (UP/DOWN, LEFT/RIGHT)
INCREMENT/DECREMENT
GO
FUNCTION**

2-3.1 MENU SCROLL/CURSOR CONTROL (UP/DOWN, LEFT/RIGHT)

These four triangular pushbuttons are physically located to the right of the LCD (display) and are basic in their function.

The UP/DOWN buttons permit scrolling up or down to select a desired menu on the LCD. The two-line menus are scrolled between the two lines by using these buttons also.

The LEFT/RIGHT buttons permit movement of the cursor left or right to the desired data entry field within the menu screen.

2-3.2 INCREMENT/DECREMENT

These two rectangular pushbuttons are located physically below and to the right of the LCD display. The top pushbutton is the INCREMENT and the bottom pushbutton is the DECREMENT.

These two pushbuttons enable the user to increase or decrease values in the menu field, or change options in the menu field that have already been selected. For those fields that have multiple values or options, each time the button is pushed the LCD will show the next value or option.

IMPORTANT: The DTS has no “enter” pushbutton to capture the field that is being changed. Once the user has finished changing the field, the DTS must recognize the changed field. This is accomplished simply by moving the cursor off the field that was recently changed. Therefore, once selection of any set value or option has been made, the cursor must be moved off the field for the selected value or option to be entered and recognized by the DTS. (The only instance where this is not true is in the “main function” menu and “cable delay measure” menu, where turning cable measure “On” immediately enables this mode without moving the cursor any further.)

2-3.3 GO

This rectangular pushbutton is located below the LCD and to the left of the Increment pushbutton. This button is used when the user is required to initiate an action external to the DTS before proceeding. The DTS will always prompt the user as to what is needed by displaying a message on the LCD and illuminating the LED adjacent to the pushbutton.

There are two conditions during which the GO button will be pushed. These are:

<u>Conditions</u>	<u>Action</u>
External Calibration	User must attach the cables which are being compensated, selects AC and/or DC calibration
Internal Calibration	Causes new calibration data to be taken
Strobe Calibration	Causes strobe delay calibration to be taken
Manual Trigger	User is performing one reading at a time

2-3.4 FUNCTION

This rectangular pushbutton is physically located to the right of the increment pushbutton. This pushbutton has many different options which are dependent on which menu is being displayed. These are:

<u>Action</u>	<u>Result</u>
If pushed when in the Memory menu	Recalls/Stores set-ups under the selected name
If pushed when in Statistics I menu, filter is On, mode is Idle	DTS calculates unfiltered data and updates menus 6 & 7
If pushed when in Printer menu	Initiates a print.
If pushed when in Pulse Finder Peaks, Main Function or Time Measurement #8 and #9	Pulse Finder is activated
If pushed when in Voltage Measurement menu	Initiates a DC or strobed voltage measurement

2-3.4-1 PULSE FINDER

There are several different results possible when the Pulse Finder has been activated (Figure 2-5). Pulse Finder sets Start and Stop threshold reference voltages based on the minimum and maximum pulse level found on each channel. In the Main Function menu the following applies:

<u>Function</u>	<u>Default</u>
If FCN: TPD++, --, +-, -+, Period, PW+, -	The CH1 and CH2 voltages are set to the 50% of each input channel
If FCN: TT+	The Pulse Finder sets the Start reference voltage at 10% and the Stop reference voltage at 90% point of the respective pulses presented at the CH1 and CH2 SMA connectors (refer to Note below)
If FCN: TT-	The Pulse Finder sets the Stop reference voltage at 10% and the Start reference voltage at 90% point of the respective pulses presented at the CH1 and CH2 SMA connectors (refer to the Note below)

NOTE: If the Pulse Finder is activated and no signals are on the Channel 1 or 2, it may find the termination voltage level. If it finds no signal including the termination voltages, it will return to its original setting.

Pulse Finder generally takes longer to find a small amplitude pulse.

Pulses should occur at a reasonable rate in order for the Pulse Finder to work. The recommended minimum rate is 1,000/second.

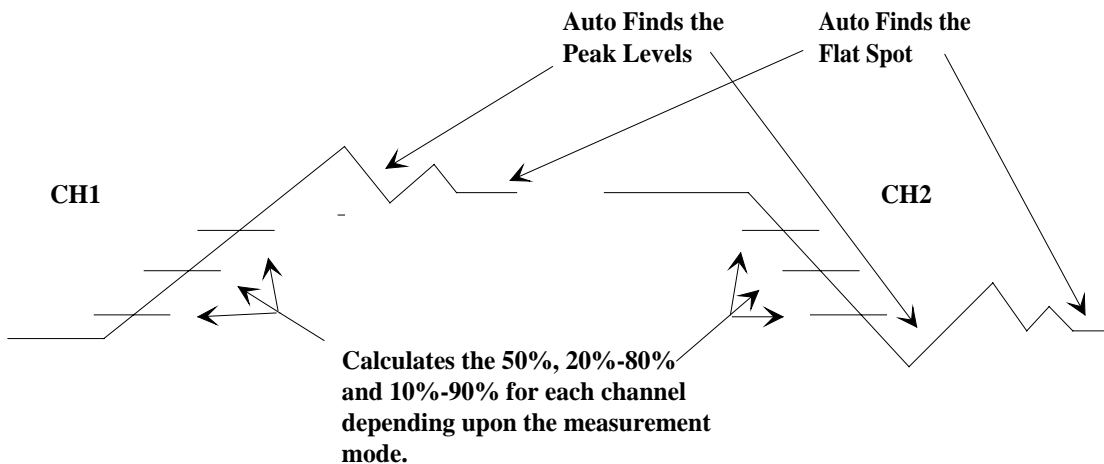

Figure 2-5. Example of Pulse Finder When Activated

2-4 MENU SELECTION

The user has the option of selecting any one of 15 possible menu screens. The grouping of these menus is graphically illustrated on Figure 1-6.

Upon Power-Up, the display screen defaults to the main function menu (menu #7). Any desired menu can then be selected by pressing either the UP or DOWN menu scroll pushbuttons directly to the right of the LCD. For example, with the default menu displayed, pressing the UP button one time steps the display to menu #6; pressing it again steps the display to menu #5, etc. Conversely, pressing the DOWN button scrolls the display to menu #8 and continuing 9 through 15.

Within any menu screen, a blinking cursor appears, designating the field, which is active. This cursor may be moved within the menu window by pressing either of the LEFT or RIGHT directional arrows.

Once the cursor has been positioned to the desired field, programming parameters within that field can be entered by using the INCREMENT/DECREMENT buttons.

2-4.1 MENU #1: PORT

IEEE-488	WAVEFORM	SCSI
ADDR = 05	Peak	ADDR = 0A CLEAR

IEEE-488: Allow the setting of the IEEE-488 bus address from 1 to 31.

The default address setting from the factory is 05. To change the default setting to another address:

1. Change the address to a new address.
2. Power down the instrument.
3. On successive Power On's, the new address will be the default.

Waveform: The Waveform selection of Peak or Flat directs the pulse find search and setting of the reference voltages. With Peak selected, pulse find will search for the peaks and with Flat selected, it will search for the major flat area of a waveform at the trailing edges of the waveform.

NOTE: See Paragraph 2-3.4-1 for more information on pulse find.

SCSI: Allows the setting of the SCSI bus address from 1 to 7 hexadecimal.

The default address setting from the factory is 5. To change the default setting to another address:

1. Change the address to a new address.
2. Power down the instrument.
3. On successive Power On's, the new address will be the default.

Clear: The CLEAR will cause the instrument to reset to the current parameters of function TPD++. The front panel will display the Main Function Menu #7. Sample size and sets size will be initialized to 1.

2-4.2 MENU #2: MEMORY - NAME/SAVE/RECALL

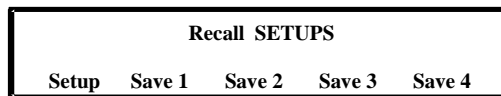

This menu is really three (3) menus in one (1). Placing the cursor on Recall, the default selection, use the increment/decrement buttons to move from Recall to NAME or Save.

There are ten (10) memories available for saving and recall setups. The names of each memory can be changed using any combination of A-Z and 0-9.

To Save or Recall, select the respective submenu and place the cursor on the name and press the FUNCTION button.

The names and information stored is not changed on a power down or clear. The information can only be changed by the operator through the front panel or a host interface.

During a Save or Recall, the following parameters are saved for later recall or recalled and used as DTS-2070 parameters:

Function Selection (defines edge direction)

Channel selection (Ch1/Ch2/Both)

Arming event arming sequence

Start reference voltage

Stop reference voltage

External Arm reference voltage

External Arm edge direction

Pulse find levels (percentages)

Start/Stop edge (rising or falling)

Sample size

Sets size

Start/Stop VOH (max peak) voltage

Start/Stop VOL (min peak) voltage

Filter On/Off

Filter minimum

Filter maximum

Start/Stop arm on Nth count

Gating on/off

Start/Stop external arming inputs

Arming source

Strobe start point

Strobe stop point

Strobe increment value

Strobe number of points

Strobe arming channel

Strobe input channel

Strobe delay

DC channel

Notes: Cable measurement mode (on/off) not stored.

Parameters listed under Function Selection are saved for each function type.

External calibration values are not stored.

2-4.3 MENU #3: PRINTER

AUTO LOG	PRINT SELECT	STATUS
Off	Statistics	Ready

This menu allows the controlling of selected printouts.

The printer supported is the Epson FX series or printers emulating these basic features.

Many modern printers support the basic features, but the operator might have to manually select the mode.

Example: HP LaserJet II

1. Place printer OFF LINE.
2. Press MENU until FONT SRC appears on the first line of display.
3. Press +/- to select I (for internal fonts).
4. Press ENTER to save selection.
5. Press MENU to display FONT NUM.
6. Press +/- until font I018 is selected.
7. Press ENTER to save selection.
8. Press ON LINE to exit menu and place printer back on line.

The printer should now be ready for printout from the DTS.

Similar types of setup to a IBM PC style of printer might have to be performed to select the following font style:

AUTO LOG - Directs the DTS to print out the statistics after each measurement.

<u>Function</u>	<u>Measured</u>	<u>Maximum</u>	<u>Minimum</u>	<u>Range</u>	<u>Jitter</u>
Period CH1	5,028.266 ps	5,066 ps	5,006 ps	29.91 ps	16.54 ps
Period CH1	5,027.826 ps	5,065 ps	5,002 ps	31.13 ps	16.53 ps
Period CH1	5,027.364 ps	5,067 ps	5,002 ps	32.04 ps	16.48 ps
Period CH1	5,027.432 ps	5,065 ps	5,004 ps	30.21 ps	16.33 ps
Period CH1	5,026.654 ps	5,065 ps	5,003 ps	31.13 ps	16.06 ps
Period CH1	5,027.637 ps	5,066 ps	5,004 ps	31.13 ps	17.19 ps
Period CH1	5,028.310 ps	5,069 ps	5,001 ps	34.18 ps	17.64 ps
Period CH1	5,027.482 ps	5,068 ps	5,004 ps	31.74 ps	17.20 ps

PRINT SELECT - Allows the selection of three (3) printouts when the 'FUNC' key is pushed:

1. STATISTICS - Statistics and instrument parameter used for those setups.
2. SETUP - Current instrument setup.
3. HISTOGRAM - Histogram of last measurement.

STATISTICS Example:

Current Test Configuration

Measurement mode : Period Ch1
Samples : 1001
Triggering : Automatic
Gating with ARM2 : Disabled
User trip levels : Disabled
Trip levels : 50% - 50%

Event sequence : Auto arm on stop
Start arming cnt : 1
Stop arming cnt : 2
Filtering : Disabled

Trip Voltages

Start event : +0.0004
Stop event : +0.0004
Ch1 peak voltages : +0.9617 -0.9610

Test Results

Samples : 1001
Sets : 1
Measured : 5,027.569 ps
Maximum : 5,067 ps
Minimum : 5,005 ps
Range : 30.52 ps
Jitter : 16.38 ps

SETUP Example:

Complete Setup

Measurement mode : Period Ch1
Samples : 1001
Triggering : Automatic
Start arming : 1
Stop arming : 1
Gating with ARM2 : Disabled
User trip levels : Disabled
Event sequence : Auto arm on stop
Start arming cnt : 1
Stop arming cnt : 2
Filtering : Disabled
Filter maximum : +2.499999999999
Filter minimum : -2.499999999999
GPIB address : 5

Trip Voltages

Start event : +0.0004
Stop event : +0.0004
Arm 1 trip level : +0.0000 Rising
Arm 2 trip level : +0.0000 Rising
Ch1 peak voltages : +0.9617 -0.9610
Ch2 peak voltages : +0.0000 +0.0000
Arm1 peak voltages : +0.0000 +0.0000
Arm2 peak voltages : +0.0000 +0.0000

HIST Example:

2-4.4 MENU #4: STATISTICS SETTING - Size & Format

SIZE -- SAMPLE -- SETS	DISPLAYED UNITS
1,000,000 0001	Automatic

SAMPLE SIZE - Selects the number of measurements taken (1 to 1,000,000) for each burst used to generate statistics.

SAMPLE SETS - Selects the count of a set of measurements used to generate statistics. The default set is 1. Sample set and size work together to provide the number of measurements in a burst.

Example 1: Size = 1000 sets = 1
One (1) burst of 1000 measurements is taken

Example 2: Size = 1000 sets = 10
One thousand (1000) bursts of size ten (10) measurements are taken. Statistics for each set (10) are generated and these statistics are used to generate the final statistics which are displayed on the front panel.

DISPLAYED UNITS - Units to be displayed is selectable from seconds (s), milliseconds (ms), microseconds (μ s), picoseconds (ps), and femtoseconds (fs). In Autoscale (AT) the display will start up to nine (9) digits before shifting to the next wait of measurement in groups of three (3) digits or scientific engineering notation.

2-4.5 MENU #5: PULSE FINDER PEAKS

MAX CHAN1 MIN	MAX CHAN2 MIN
+0.0000 +0.0000	+0.0000 +0.0000

Displays the peak or flat level, determined by the waveform selection on Menu #1, of the input channel reference voltages. See Paragraph 2-3.4-1, Pulse Finder, for more information.

With the cursor in this menu and the FUNCTION button pressed, the minimum and maximum voltages of the input signal will be found

2-4.6 MENU #6: STATISTICS I - Min/Max & Samples Taken

1,000,000/1,000,000	MX = 20ps
	MN = 40ps

Samples Completed/Samples Size - The current number of measurements taken and the sample size are displayed. The current samples completed are updated approximately every one (1) second.

MX & MN - At the completion of a burst, the minimum and maximum values are displayed in this menu. The displayed units are selected by the displayed units in Menu #4.

MX = Maximum value read
MN = Minimum value read

2-4.7 MENU #7. STATISTICS II AND MAIN FUNCTION



FCN: TPD++ 	MEAS: 1ps
TR: 50% - 50% CH: 1-2 RG = +1.73ps JT = 4.57ps	

FCN - Allows the user to select one (1) of ten (10) different measurement functions: TPD++, TPD--, TPD+-, TPD-+, TT+, TT-, PW+, PW-, Period and Frequency. In addition, this menu allows the user to select different start and stop voltage levels. These include 50%–50%, 20%–80%, 80%–20%, 10%–90%, and 90%–10% which are automatically calculated for the user only after the pulse finder has been invoked by pressing the function push button. User voltage settings can also be entered by changing the voltage settings for the Start and Stop reference voltages manually, in menu #8. When taking a single channel measurement (TT+, TT-, PW+, PW-, PER and FREQ), the user is able to select either the 1 or 2 channel for the measurement.

Each measurement function has its own default setups for voltage settings, channel selection, level percentages, and forced measurement modes. In most applications these defaults are intended to change the DTS setups to perform these measurement functions. If for some reason these measurement setups need to be changed for a specific application, the new setup becomes the default setup for that function.

The reference voltage level is also set on a channel-by-channel basis. This means that the user can have different reference levels for each channel of the same function, such as Period or Pulse Width, etc. Toggling between channels will change the reference trip point for the channel.

2-4.8 MENU #8: CHANNEL VOLTAGE REFERENCES

CHAN 1 START VREF	CHAN 2 STOP VREF
 ± 0.0000v	 ± 0.0000v

Provides for the selection of voltage trip levels for the Start and Stop. Also the rising/falling edge to be used for the measurement Start and Stop is selectable.



The Pulse Find feature can be used to eliminate the need of set the trip reference voltage. This feature finds the percentage of the input signals on Channel 1 and 2 and set the Start and Stop voltage reference to these values.

The voltage limits of the DTS-2070 are \hat{u} 1.11 volts.

With the cursor positioned in this menu, pressing the FUNCTION button will initiate a pulse find.

See Paragraph 2-3.4-1, Pulse Finder, for more information.

2-4.9 MENU #9: EXTERNAL ARMING VOLTAGE REFERENCES

1	EXTERNAL ARM	2	GATE
 +0.0000v	VREF	 +0.0000v	OFF H

Provide for the selection of voltage trip levels for the arming inputs. The rising/falling edge can also be set for the arming inputs.

The Pulse Finder feature can be used to eliminate the need of setting the arming channel voltage references if the 50% of peak to peak is the desired voltage.

Pulse Finder will only search for the arming inputs if the trigger source (auto/external) is in external. Pulse Finder will also only find the arming input value if that arming input is selected in Menu #10, Select External Arm.

The voltage limits of the DTS-2070 are \hat{u} 1.11 volts. See Paragraph 2-3.4-1, Pulse Finder, for more information.

Provides for the selection of External Arm 2 to be a level sensitive GATE. A selection of ON or OFF will select gating. The External Arm voltage reference input is used to select the direction and level of the gating. The operator can select H (high) or L (low) which is the same as changing the External Arm 2 edge. See Paragraph 2-6.5, Gating, for more information.

2-4.10 MENU #10: EXTERNAL ARMING SELECTION



Select which arming input is used to arm the Start event and arm the Stop event. The DTS-2070 has two (2) arming inputs (ARM1 and ARM2).

See Paragraph 2-6, Arming, for more information.

2-4.11 MENU #11: ARMING SEQUENCE SELECTION



Selects the arming sequence to use in making a measurement. In the DTS-2070, the arming sequence is selectable with the trigger source either automatic or external.

There are four (4) sequence modes:

- Arm On Stop**
- Arm On Start**
- Arm Start First**
- Arm Stop First**

See Paragraph 2-6, Arming, for more information

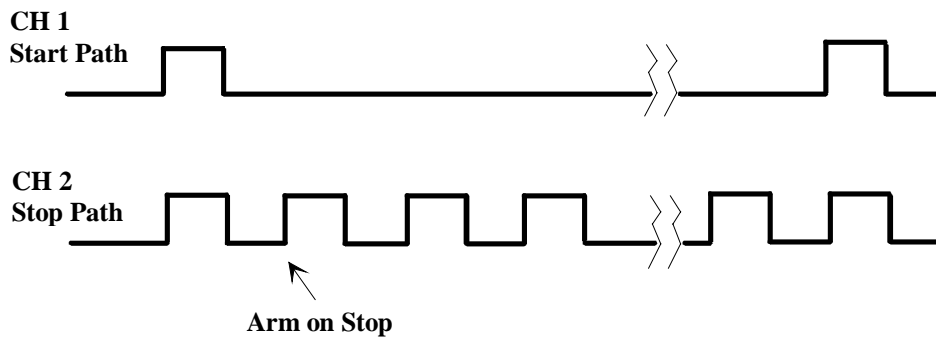

Figure 2-6. Arm on STOP and START

2-4.12 MENU #12: ARMING COUNT SETTING

SELECT ARM ON COUNT	
START: 001	STOP: 001

Selects the Start or Stop event arm on Nth count. The range is 1 to 256.

This feature can be used to select the number of edges or pulses to skip before starting or stopping a measurement.

See Paragraph 2-6, Arming, for more information.

2-4.13 MENU #13: VOLTAGE MEASUREMENT - DC AND STROBED

STROBE INPUT SELECT	CHAN	DELAY	V LEVEL
DC	1	008.500ns	+0.0000v

Allows voltage measurement from the front panel.

STROBE INPUT SELECT - Selects whether a DC or strobed voltage measurement will be performed. Three (3) selections can be made:

- DC Measure the DC voltage on channel selected.
- ARM1 Measure the strobed DC voltage on selected channel at delay from selected arming point using ARM1 input.
- ARM2 Measure the strobed DC voltage on selected channel at delay from selected arming point using ARM2 input.

CHAN - Select input channel for DC or strobed voltage measurement.

DELAY - Sets the delay that the strobed measurement occurs from the arming trip point.

VLEVEL - Displays the voltage measured.

With the cursor in this menu, pressing the FUNCTION button will initiate a voltage measurement.

2-4.14 MENU #14: TIME FILTERING

- UPPER LIMIT-	-LOWER LIMIT-	FILTER
±2.49999999999	±2.49999999999	Off

The DTS-2070 performs a digital band pass filter function.

This menu permits selection of upper and lower limits of values to be used in measurement calculations. Any readings outside these limits are discarded.

Both the upper and lower limit may be selected from -2.5 sec to +2.5 sec, but the upper limit setting must be greater than the lower limit setting. The DTS will not allow the user to violate this from the front panel. When entering the upper limit first, always keep the values in the upper limit greater than the lower limit. Enter the lower limit second.

The maximum sample size allowed with filter enabled is 8,000. If the sample size is greater than 8,000 and the filter function has been set to On, the system sets the sample size to 8000.

One of the features of the time measurement used in the DTS-2070 is that the DTS will measure all of the pulses with respect to one of its inputs, depending on which measurement mode is selected. For example, if TPD++ is selected and there are 10 pulses on Channel 2 for one on Channel 1, and if Arm on Stop is selected, and if a Burst of 1,000 is selected, then the DTS will measure the TPD++ for each edge on the Channel 2 with respect to the one on the Channel 1. Then 100 measurements will be made for each TPD++ measured. Refer to START/STOP example below and the representation in Figure 2-7.

$$(\text{burst} \div \text{number of pulses} = \text{count/TPD}) \text{ or } (1,000 \div 10 = 100)$$

The band pass filter is used to select only the desired TPD you want displayed (Figure 2-7). Notice that all the data is in the memory and each measurement can be read over the GPIB and the distribution for each of the 10 TPDs calculated off-line by an external processor.

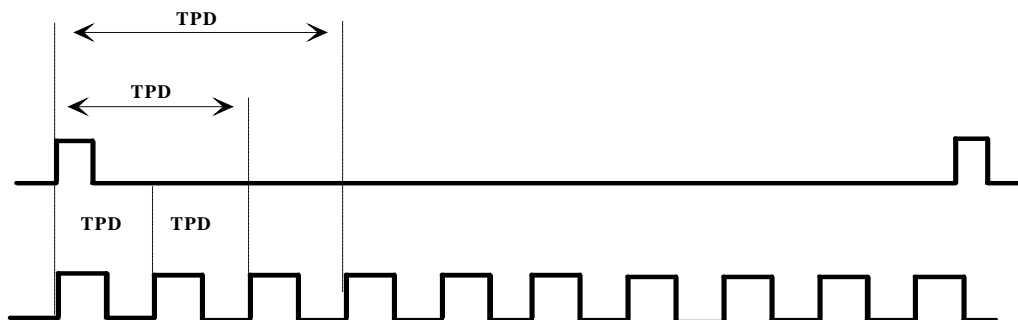

Figure 2-7. Band Pass Filter

Filter Theory

The user should understand the way measurements are taken when Filter = On. First, the data for the sample is collected and each individual time is computed. Second, any values outside the limits are discarded. Third, statistics are calculated based on the reduced number of readings.

When Filter = On, the average, standard deviation, and range does not include the readings outside the limits. The number of readings displayed in the statistics menus will be the number of readings that were within the limits. Minimum and maximum also reflects the readings inside the limits.

If Filter = On and no readings were within the limits, the sample completed number will be 0. The standard deviation will read -999,999,999 seconds and the message displayed will be:

NO VALUES IN RANGE

2-4.15 MENU #15: CABLE MEASUREMENT

CABLE LENGTH MEASUREMENT	MEASURE
DLY = 0 ps	Off

This menu allows the measurement of a cable to obtain its electrical length. The cables measured must be a 50 Ohm coax cable. The procedure for measuring a cable is as follows:

Note: When measure is turned 'on' the hardware turns on a 1 MHz sq wave pulse at the Cal 1 & 2 outputs. If desired, the user can use any frequency of signal as long as it is '0' crossing and it's period is longer than the electrical length of the coax being measured.

1. Connect the "cal 2" to the Channel 2 with a short length of 50 Ohm coax.
2. Connect the "cal 1" to the Channel 1 with the cable measurement fixture to be used to measure all subsequent 50 Ohm cables.
3. Enable the cable measurement mode by selecting ON in the menu.
4. Press the BURST push button.

The DTS will briefly display the following message:

Subsequent Cables will use this cable arrangement as a reference.

Note: This means that the DTS "zeroed out" the particular cable arrangement just measured. To verify this, press BURST a second time. The value read should be close to zero picoseconds.

5. Open the connector connecting the CAL 1 to Channel 1 and insert the cable to be measured.
6. Press the CONT or BURST push button.

The observed time is the electrical length of the cable being measured.

Note: Cable length measurement changes the front panel setup. It changes the forced measurement mode to “Auto Arm on Start”, function to TPD++, START, STOP voltages to “0” volts.

Note: A signal validity check is made at the startup of cable measurement. A check that the signal is greater than 30 millivolts is made and if not, a message is displayed:

**SIGNAL LESS THAN 30 mV AMPLITUDE
CABLE MEASUREMENT FAILED**

2-5 MODE SELECTION

There are five hardware modes on the DTS. Refer to Figure 2-8 for the Flow Diagram. These are:

Internal Calibration	Used to calibrate the internal circuits
External Calibration	Used to calibrate/deskew inputs
Burst	Used to take one set of readings equal to the Sample Size
Continuous	Used to take multiple sets of readings equal to the Sample Size
Idle	A wait state usually encountered after a Burst is complete or Power-On.

2-5.1 INTERNAL CALIBRATION (Labeled INT CAL)

The DTS requires a minimum warm-up period of 30 min. for measurements and distributions to be within specification.

After the recommended warm-up, to initialize the internal calibration sequence, push the INT CAL button on the front panel.

A message will be displayed:

**INTERNAL CALIBRATION
PRESS GO WITHIN 5s TO CONTINUE**

If the user does not respond within 5 seconds the internal calculation will not be done.

When the GO button is pressed, a message will be displayed:

INTERNAL CALIBRATION 300 SECONDS TO GO

This indicates the amount of time remaining to accomplish all of the internal calibration procedures. The calibration process is uninterruptable once the INT CAL switch is activated. The display will begin counting down from 300 sec. When the countdown reaches 0 sec., the display will change to:

CALIBRATED

The previous mode and display then returns.

If a power loss occurs during the calibration and prevents its completion, the DTS will recommend an Internal Calibration, the next power-up. If this should happen, power up and wait 30 minutes; then calibrate again.

2-5.1-1 INTERNAL CALIBRATION OPTIMIZATION

Internal calibration should be performed after the DTS has been powered-on for at least 30 minutes in a temperature-stable environment. The calibration is valid for varying time periods, depending on the operating environment. The most important factor necessitating a recalibration is a temperature change greater than the specifications. Wave's quotation of ± 30 ps single shot accuracy depends on a recent calibration and temperature drift less $\pm 5C$.

An external calibration should be performed after each internal calibration. See Section 2-5.2

Internal calibration can be manually initiated at any time, without disconnecting external fixtures.

2-5.2 EXTERNAL CALIBRATION (Labeled EXT CAL)

External calibration for cables or probes can be accomplished in the same manner. When probes are used, an appropriate probe tip to SMA adapter should be installed at the CAL1 and CAL2 SMA connectors.

To initialize External Calibration, push the EXT CAL pushbutton. This will initiate the sequence for measuring and compensating for cable length. The display will read:

**EXTERNAL CALIBRATION
PRESS GO WITHIN 5s TO CONTINUE**

If the user does not respond within 5 seconds, the external calibration will not be done.

When the GO button is pressed, the following message will be displayed:

**PRESS GO WITHIN 5s TO PERFORM
DC CALIBRATION PHASE**

If the user does not respond within 5 seconds, the DC calibration phase will not be done. Go to AC calibration.

DC CALIBRATION

When the GO button is pressed, the following messages will direct the user through the DC calibration:

**APPLY SHORTING CAPS TO ALL INPUTS
PRESS GO**

The shorting caps were shipped with the instrument and provide a ground to calibrate any offset from ground.

**REMOVE SHORTING CAPS
PRESS GO**

Calibrates for any current compensation of the voltage divider network at the input of the A to D's.

**GROUND INPUTS FOR CH1 AND CH2
PRESS GO**

Calibrates for any voltage reference difference caused by the probes being used between Channel 1 & 2.

**DC CALIBRATION PHASE FINISHED
PRESS GO**

AC CALIBRATION

CONNECT CH1 TO CAL1 CONNECT CH2 TO CAL2, PRESS GO

This message instructs the operator to connect the external cables or probes to be calibrated to the correct SMA connectors. Once the connection is made, press GO and the instrument will automatically calibrate the cable connected to CH1 and CH2. The LCD will then display the following:

CROSS CABLE CONNECTIONS AT CAL SIGNAL CONNECTORS, PRESS GO

This message instructs the operator to connect the CH1 cable to CAL2 and CH2 cable to CAL1 (refer to NOTE below). Once the connection is made, press GO and the instrument will automatically calibrate the cable connected to CH1 and CH2. The LCD will then display the following for two seconds:

CALIBRATED

The previous mode and display then returns.

The unit has calibrated for the difference in the cable length of the external probes and the software will maintain “constants” and will use these numbers when calculating time measurements.

Pressing any other switch during calibration also causes the previous mode and display to return. Calibration values are still defined as before.

NOTE: When this message appears, cross the cables only if a different interface is to be used than the one being used for the calibration. In other words, **DO NOT CROSS** the cables or probes if all future measurements are to be made with the probes or cables being used for the calibration.

CALIBRATION VALIDITY CHECKS

Before starting the calibration, a check is made to ensure the signal has an amplitude greater than 100 millivolts. If not, a message is displayed:

PULSE < 100mV

After each calibration measurement, the jitter of the measurement is checked for less than 100 picoseconds. If not, a message is displayed:

JITTER > 100 ps

At the end of the External Calibration, a check is made that the measurements were reasonable. If not, a message is displayed:

CAL NOT GOOD

2-5.2-1 EXTERNAL CALIBRATION THEORY OF OPERATION

The user should understand the basic purpose of external calibration. It establishes zero reference points so subsequent readings can relate to the same condition as the “zero” point. External calibration does not just measure the difference in the lengths of the cables; the process calculates the delays all the way to the logic inside the DTS. Note that there is a separate path for each of the 16 possible combinations of the rising and falling signals so 16 offsets are calculated and saved. This makes it unnecessary to recalibrate if you do an external cal in rising/rising mode and then change to falling/falling. However, if cabling is changed, one must recalibrate to obtain valid, absolute measurements.

The DTS-2070 uses a zero-crossing 200-MHz sine wave with a harmonic content of less than -50 db. The references are set to zero (0.000) volts during this calibration, and the input termination is set to GND.

After external calibration is complete, a quick check of the effectiveness of the calibration can be made by placing all voltage references on the Start and Stop channels to 0.000 volts. Record the measurement values for each option. Cross cable connections at Cal signal connectors. Scroll through the measurement options again, and record their measurement values for each option. The average of the two measurements for each option should be as follows:

- 1) TPD++, TPD--, TT+, TT- 0 ps ±10 ps
- 2) PW+, PW-, TPD+-, TPD-+ 2,500 ps ±10 ps
- 3) Period 5,000 ps ±10 ps
- 4) Frequency 200 Mhz ±1 Khz

Cable Length Restriction:

NOTE: Because of the 200-MHz sine wave used for “EXT CAL” the maximum cable length delta between CH1 and CH2 is 30.0 cm.

2-5.3 BURST (Labeled BURST)

Pressing the BURST mode pushbutton causes the DTS to begin taking readings. The indicator light will stay lit until this mode has been completed.

The number of readings taken (1 to 1,000,000) will correspond to the sample size selected. When BURST has completed taking the number of readings equal to the sample size, the new computed data is displayed and stored. It can be observed by using statistics menus. The BURST indicator is extinguished and the DTS returns to an idle state.

A Burst of up to 40,000 measurements are stored in the DTS memory and can be read over the GPIB for special processing. When the filter is “On”, up to 8,000 measurements are stored and read over the GPIB.

If BURST was interrupted by pressing any other mode pushbutton, the last good computed data is returned (any unprocessed data is lost).

BURST must be pressed again to accept another set of samples.

2-5.3-1 SPECIAL CASE

If FILTER is enabled, and BURST has been completed, only the number of readings taken within the bounds of the filter will be displayed.

For example, if 1,000 readings were requested and 10 readings were outside the bounds of the filter, 990 readings would be displayed along with the computed data of the 990 readings.

If the Statistics I menu is being displayed, the computed data for all 1,000 readings can be updated and displayed by pressing the FUNCTION button.

If a new BURST is initiated without pressing the FUNCTION button, the data for the 10 readings outside the filter boundaries is lost.

2-5.4 CONTINUOUS (Labeled CONT)

Pressing the Continuous mode pushbutton causes the DTS to begin taking readings. The indicator light will stay lit as long as the DTS is in this mode.

The DTS continues reading until it has measured the number of pulses (1 to 1,000,000) entered into the sample size display (up to 40,000 are stored in memory).

After CONT has completed taking the readings equal to the sample size, the new computed data is stored and displayed, and the process begins again to collect a new series of measurements equal to the entered sample size.

If CONT is interrupted by pressing any other mode pushbutton, the most recent computed data is displayed.

If FILTER is enabled, only the number of readings taken within the bounds of the filter will be displayed. For example, if 1,000 readings were requested and 10 readings were outside the bounds of the filter, 990 readings would be displayed along with the computed data of the 990 readings. The data for the 10 readings outside the filter boundaries is lost.

2-5.5 IDLE

Idle is a default mode, since it merely represents a defaulted, or waiting, condition usually after a BURST has been completed.

2-6 ARMING

The user can select any one of 3 Arming modes via the GPIB or from the front panel. There is a separate button on the front panel for each of the 3 Arming modes. When one of the buttons is pressed, a light on the button will light to indicate the mode the DTS is in.

2-6.1 ARMING SOURCE SELECTION

The user has the option of selecting one of three Arming sources on the DTS. The Arm pushbuttons are located immediately above the Arm SMA connection on the lower right of the front panel.

Automatic Arm
External Arm
Manual Arm

The Default Arm mode is “Auto Arm”.

2-6.1-1 AUTOMATIC ARM (Labeled AUTO)

Pressing the Automatic Arm pushbutton allows readings based on the edges of the CH1 and CH2 pulses. The DTS collects the number of samples selected, computes statistics, and displays them in the Statistics I and Main Function menus.

Enable/Arm mode (menu #11) allows selection of several measurement modes and should be referenced when using Auto Arm. The DTS selects the last used enable mode when powered up.

The number of measurements corresponds to the displayed sample size. When measurements equal to the sample size have been collected, computations are made and displayed.

If Burst mode is selected, no further pulses are accepted without initializing Burst mode again.

If Continuous mode is selected, a new series of measurements will begin immediately.

Pressing any other Arming function switch deactivates the Automatic Arm and extinguishes the AUTO indicator light.

2-6.1-2 EXTERNAL ARM (Labeled EXT)

Pressing the External Arm pushbutton allows an external signal source to arm the instrument. The operator selects a voltage level between $\pm 1.11\text{V}$, using menu #8.

Once armed, the DTS measures the next pulse to be presented, with one measurement collected each time EXT Arm signal is received. In 'Gate' mode the DTS measures as long as gate is in selected mode.

The number of measurements corresponds to the sample size selected. When the number of measurements equal to the sample size is collected, computations are made and displayed in the statistics menus.

If Burst mode is selected, no further pulses are accepted without initializing Burst Mode again.

The External Arm signal required is any pulse of a minimum duration of 1 ns pulse width occurring 3 ns before the signals on the Ch1 or Ch2 inputs.

See Section 2-6.5 for using External Arm input as "Gate"

2-6.1-3 MANUAL ARM (Labeled MAN)

Pressing the Manual Arm pushbutton allows the GO switch to arm the Time Measurement Unit. Once armed, the DTS measures the next pulse to be presented. One measurement is taken each time GO is pressed. The MAN indicator light stays lit until a complete set of readings is taken.

The number of measurements corresponds to the displayed sample size. When measurements equal to the sample size have been collected, computations are made and displayed in the statistics menu.

If Burst mode is selected, no further pulses are accepted without initializing Burst mode again.

If Continuous mode is selected, a new series of measurements can begin immediately.

Pressing any other Arming function switch deactivates the Manual Arm and extinguishes the MAN indicator light.

2-6.2 ARMING SEQUENCE (ENABLE) MODES

Enable modes are program selectable from the GPIB or from the front panel menu 11. The purpose of the enable modes is to help resolve potential ambiguous situations that can occur, especially when Auto Arming. An ambiguous occurrence would be measuring negative time when you wanted to measure positive time even though both measurements would be valid.

All of the enable modes work in conjunction with which Arming source the user selects, Auto arm, External arm, or Manual arm. The sequence of events for taking a measurement:

Note: The following sequence of events describe how the hardware works. It is important to note that each Function in the DTS has an Enable Mode associated with it. From the front panel or GPIB host interface always select the function before changing a parameter association with a specific function, such as the enable mode.

1. The selected Arming source is satisfied.
2. The selected Enable mode condition is satisfied.
3. The selected Function criteria is satisfied.
4. The measurement is made.

In the simplest case if the user is “Auto Arming” and wants to measure the TPD++ skew between two pins of an IC, the sequence of events would be:

1. Select “AutoArm”.
2. Select “Enable Arm on Stop”.
3. Select the Function TPD++.
4. Make the measurement by executing the “Burst” command.

Executing the above sequence will enable the DTS to automatically Arm itself whenever the “CPU ready” is up. The DTS then looks for a Stop event to occur on the “Stop Path” and then starts the measurement on the next pulse whether it be on the START of STOP paths. In the case of a TPD++ measurement, see Figure 2-9.

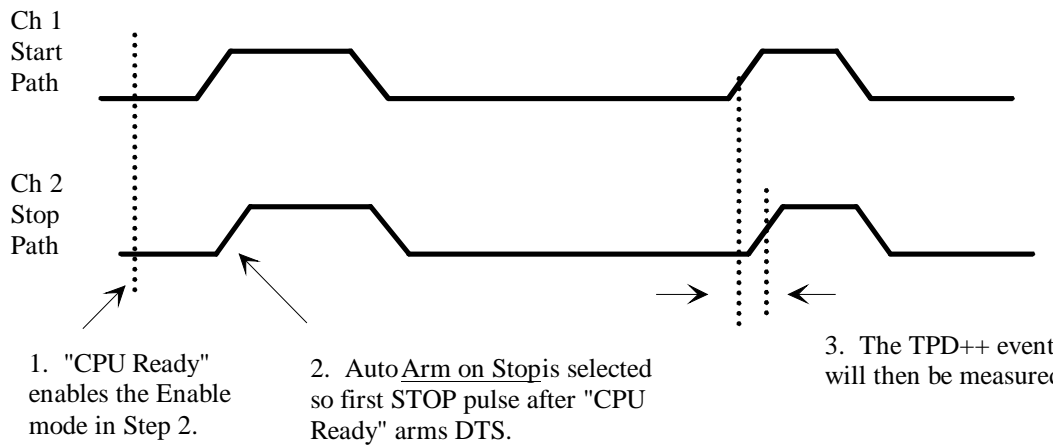

Figure 2-9. Arm on Stop

“Enable Stop after Start” or “Enable Start after Stop”

This enable mode was developed for the case where the customer wants to measure a TPD event on random data with respect to a clock signal without any special external arming. In this figure, the application is to measure the clock (cp) setup time with respect to the data input. The DTS execution sequence would be:

1. Select Arming mode “Auto or Ext”.
2. Select “Enable stop after start”.
3. Select function to be measured, “TPD++” or “TPD-+”.
4. Execute measurement.

In Figure 2-9, selecting enable mode “Enable Stop after Start” would have also worked. This later mode assures positive time measurements when there is random events occurring. Although, in the case of differential output skew measurements using “Arm on Stop” assures the ability to make positive time measurements.

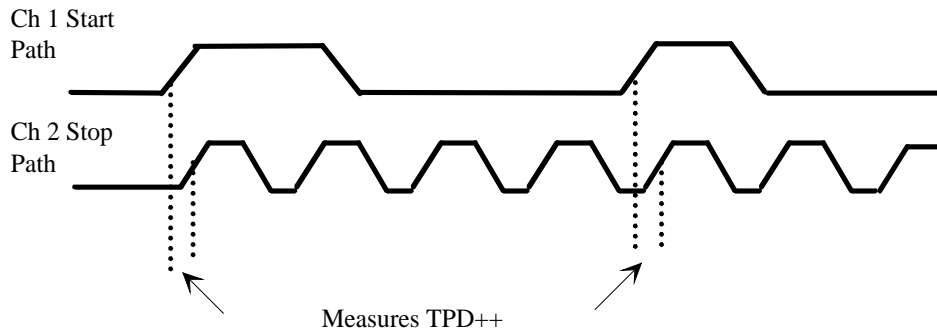

1. Measure selected TPD mode only after Start event occurs.

Figure 2-10. Arm Stop After Start

This enable mode enables the DTS to ignore clock (cp) pulses on Channel 2 that do not occur directly after the selected data pulse on Channel 1 (see Figure 2-10). As before the measurement will be in positive time because of the “Start after Stop” or “Stop after Start” modes. In fact, if no event occurs that meets the above selected criteria the DTS will not make a measurement but instead will return a “No Pulse Found” message.

2-6.3 USING THE ARMING SOURCE AND SEQUENCE TOGETHER

Auto Arm

The Default ARM source for the DTS-2070 is Auto Arm. With the DTS there is much the user can do without using any of the synchronous arming modes.

For example, measuring jitter with any of the measurement Functions using Auto Arm enables a worse case jitter measurement. By using Auto Arm the DTS asynchronously or randomly measures the selected parameters. If a statistically large enough sample size was selected for the jitter measurement, the user can be assured of catching most any randomly occurring event. These events would escape detection with a DSO sampling scope or any other triggered instrument. Refer to Wave App Note 112 on measuring Jitter for more details on how to use.

Because the DTS “Enable Modes” use the actual channel inputs for stimulus, “External Arming” is not necessary for most types of measurements. In fact the only time the user must use External Arm is when he/she wants to synchronize the DTS measurement with a specific event in the data stream.

A case like this would be a random data stream or vector set from an ATE tester. The user may want to make a measure 101,356 cycles into the vector set. The External Arm input would be used to enable the DTS prior to the parameter the user wants to measure.

In cases where the signal input is reoccurring or is a repeating pattern, then the DTS does not need to be Armed externally. In fact the main benefit of running the DTS in Auto mode is to catch the stray random event that would escape the real time or sampling oscilloscope (see Figure 2-11).

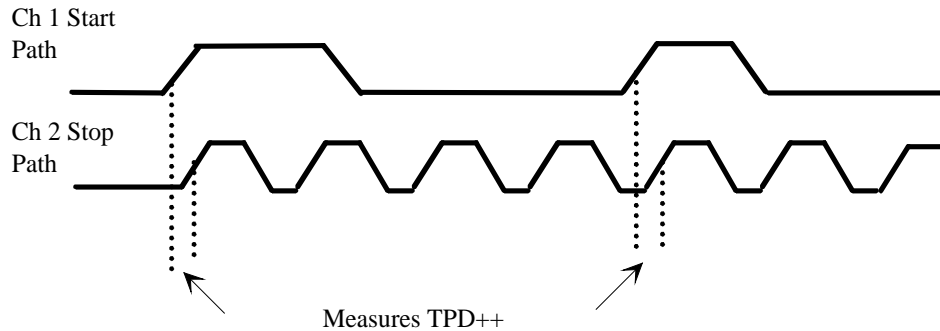

1. Measure selected TPD mode only after Start event occurs.

Figure 2-11. How Auto Arm Works

In Figure 2-11, the user wanted to measure the function TPD++. They also selected Auto Arm and Enable on Stop. Figure 2-11 shows the sequence of events leading up to the actual measurement. If a Sample Size count was set to some number like 1000 then the above cycle would repeat itself 999 more times.

The results of all 1000 one-shot measurements are stored in DTS memory and statistically analyzed to display the AVERAGE, \pm RANGE and RMS JITTER. The \pm RANGE is the min/max spread of the 1000 measurements and represents the RMS jitter in a gaussian distribution. The AVERAGE is the center of the distribution.

External Arm

Arming inputs 1 and 2 are multifunctional. The following are selectable via the GPIB or front panel menus 9 & 10.

Menu 9:

1. Enter the external voltage reference trip point for Arm 1 & 2. If "Pulse Find" is executed while the DTS is in External Arm mode, the Arming trip point levels will automatically be found and entered into these registers for the user. The value entered will be the 50% point of the arm channel.
2. Select the edge direction of the external Arm signal to arm the channel inputs by changing the direction of the rising/falling symbols in front of each reference voltage.

Menu 10:

1. Select which Arm, 1 or 2, arms which Channel 1 or 2. Arm 1 or 2 can separately arm Channel 1 and 2, or Arm 1 or 2 can arm both channels (see Figure 2-12).

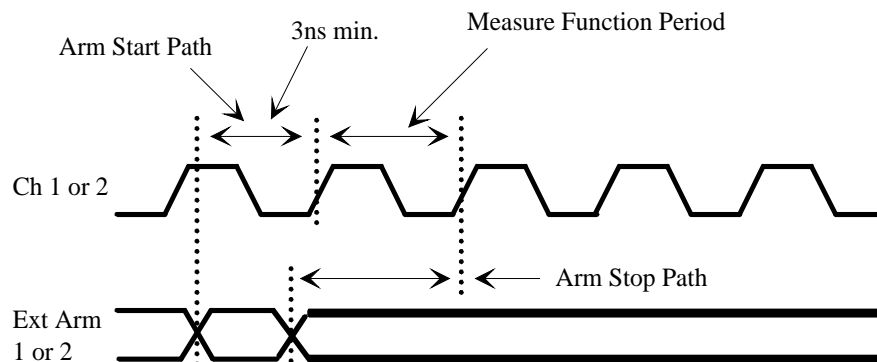

Figure 2-12. External Arm

For example, both channel inputs 1 and 2 can be armed by the same arm signal. To do this, connect the desired arming signal through a power splitter to both arming inputs, 1 and 2. The user could then choose to arm Channel 1 on the rising edge of the Arm 1 and Channel 2 on the falling edge of Arm 2. In that way the pulse width of the arming signal controls the time duration between the measurement taken between Channels 1 and 2 or on the same channel (see Figure 2-13).

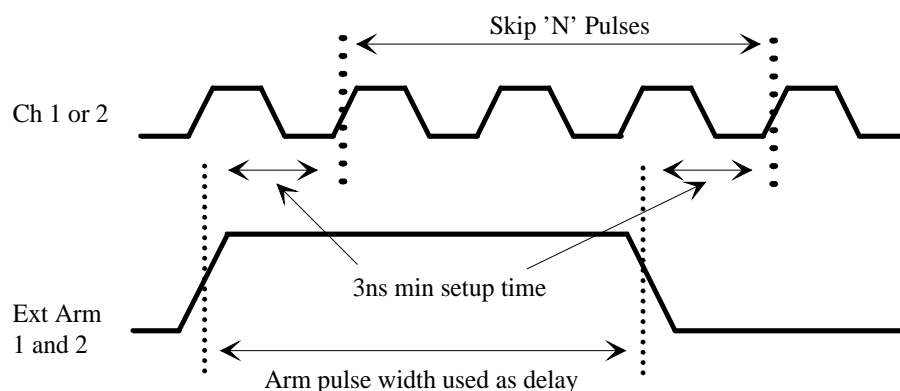

Figure 2-13. External Arm With Delay

Manual Arm

In the Manual Arm mode, the DTS is armed by pushing the GO button on the front panel or via the GPIB in the same manner. The DTS would work in the same manner as if it were in the External Arm mode, except the external arming would be done manually instead of electrically.

This mode is useful when the user wants to synchronize the DTS with some experiment such as the turning on of a power supply to look at the power up jitter of a PLL. This mode is also useful in setting up the DTS to wait for some randomly occurring event that the user is trying to catch in one-shot mode.

2-6.4 AMBIGUITY

Whenever the DTS is making a time measurement, it is possible to get the CH1 and CH2 pulses in either order. It is important to know the DTS always measures and displays time as follows:

Positive Time T **Always when CH1 occurs before CH2**

Negative Time -T **Always when CH2 occurs before CH1**

The fact that the DTS keeps track of which pulse comes first in a typical measurement and can give both a positive and negative result and can cause some concern and confusion when taking readings. The DTS with its different arming modes minimizes the possibility of ambiguity, but the user should be fully aware of the DTS arming capabilities such that he/she can use the DTS to its fullest and avoid potential ambiguous readings.

The DTS offers several different arming capabilities to solve ambiguity. It is possible, especially with the requirement that the EXT Arm pulse be 3ns prior to the signals to be measured, that a confusing set of readings can happen. The example in Figure 2-14 shows a proper setup which will not give any ambiguous reading. The following two examples (Figures 2-14 and 2-15) help explain a situation which would result in ambiguity.

Example 1 - Proper Setup:

- 1) The DTS is in EXT Arm mode and is waiting to be armed by the external signal.
- 2) A test setup is configured such that the EXT Arm signal is placed 3 ns in front of the CH1 and CH2 pulses at the setup.
- 3) There are three cables for CH1, CH2, and EXT Arm to the DTS which are exactly the same length.
- 4) The time expected to be read is “t” the propagation delay represented in the diagram between the two pulses, one on CH1; one on CH2.
- 5) The “System Arm” represents the EXT Arm signal as seen at the DTS.

Notice in this example, since the cables are the same length, the System Arm at the DTS arrived at the proper time, 3 ns prior to the two events to be measured.

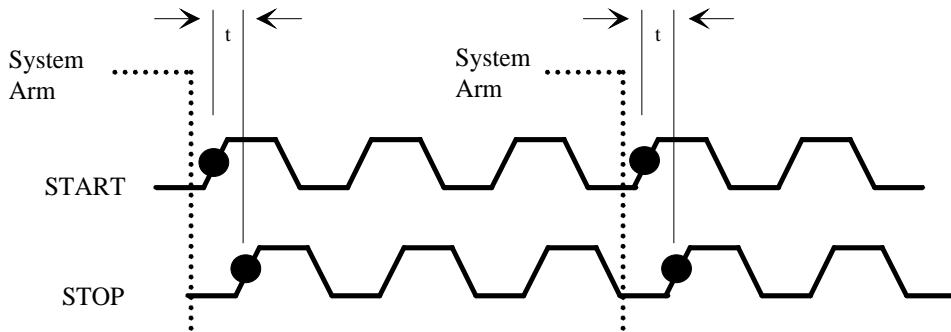

Figure 2–14. Example 1 - Proper Readings

In this case, the expected results were obtained, which was to see “t”, a positive propagation delay between CH1 and CH2.

Example 2 - External Arm Delayed:

- 1) The DTS is in EXT Arm mode and is waiting to be armed by the external signal.
- 2) A test setup is configured such that the EXT Arm signal is placed 3 ns in front of the CH1 and CH2 pulses at the setup.
- 3) There are two cables for the CH1 and CH2 which are exactly the same length. The third cable for the EXT Arm is a little longer than the other two cables.
- 4) The time expected to be read is “t”, the propagation delay represented in the diagram between the two pulses, one on CH1; one on CH2.
- 5) The “System Arm” represents the EXT Arm signal as seen at the DTS.

Notice, in this example, since the cable for the EXT Arm was a little longer, the System Arm signal seen at the DTS arrived at the wrong time. In fact, it arrives later than the CH1, but before the CH2.

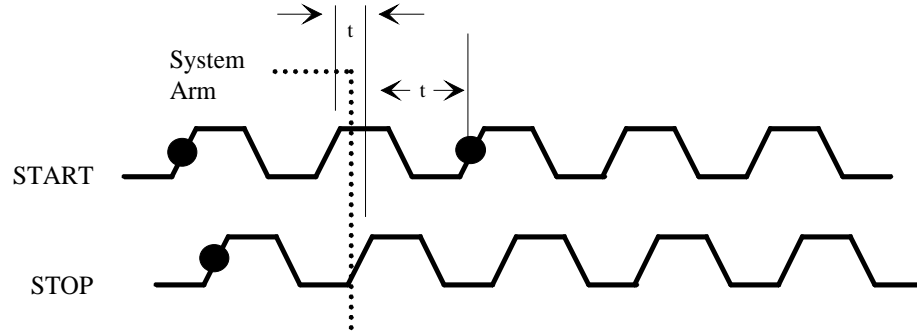

Figure 2–15. Example 2 - Arming Signal Delayed

In this case, the expected results were not obtained, which was to see “t”, a positive propagation delay between CH1 and CH2. Instead, the DTS measured the time between the CH2 and CH1 and the result was a “-t”. This could be interpreted as an ambiguity reading.

These examples are not to imply that every situation can be solved by using the right cable length, but to merely point out the potential ambiguity.

Example 3 - Positive and Negative Readings

- 1) The DTS is in EXT or AUTO Arm mode.
- 2) If in EXT Arm mode, a test testup is configured such that the EXT Arm signal is placed near the edge of the Arm window shown in Figure 2-16.
- 3) If in AUTO Arm mode, signals are applied to the CH1 and/or CH2 inputs and the DTS is making measurements.
- 4) As an example, the DTS is measuring TPD++ using AUTO ARM ON STOP

The DTS arms the start and stop paths approximately 3ns after the rising edge of the signal on the CH2 input. Because of jitter this can cause a condition to occur where the CH1 signal is missed until the next pulse occurs. A negative reading for 't' will occasionally result when this situation exists. One method of eliminating any negative readings is to delay the CH1 signal a known value. If dealing with the average statistic, these readings are just part of the average.

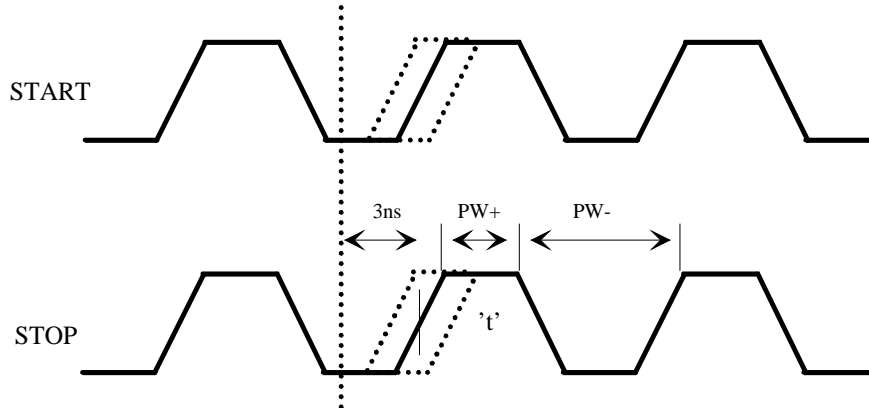

Figure 2-16. Example 3 - Getting Both Positive & Negative Readings

The potential for positive and negative readings increase with faster pulses because of jitter in the signals. The band pass filter capability can be used to filter out undesired readings of a measurement.

2-6.5 GATING (USING ARM 2 INPUT)

The instrument can use the Arm 2 input as a “gate” of arming.

When External arming, the Arm 2 input on the front panel can be used as an EDGE sensitive ARMING input or as a LEVEL sensitive GATE. In menu 9 the user selects how Arm 2 input will be used (see Figure 2-17).

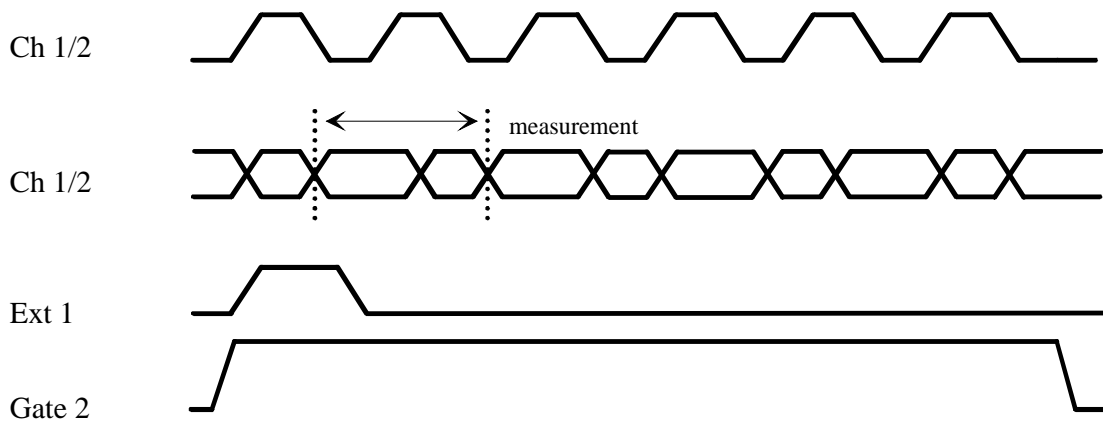

Figure 2-17. Gating Mode

The main difference between using Arm 2 input as a gate vs. edge sensitive is the DTS will make measurements whenever the gate meets the user selected criteria, whereas, if Arm 2 is edge sensitive the DTS will only make a measurement once for every edge of the arming signal. In menu 9 the user can turn the gate “ON” or “OFF” and select whether to arm the DTS when the gate is HIGH or LOW.

In Figure 2-17 the DTS was set up to make measurements based on the following criteria:

1. Is the Gate High?
2. Is the Arm 1 input going high?
3. Enable Stop after Start.
4. Make the selected measurement; Period in this case.

The GATING mode is useful if the device to be tested has a “ready or lock” signal such as when a PLL is locked onto some serial pattern. For instance, the user may want to only measure the period when the PLL is locked and the data is high and measure again when the PLL is not locked while the data is high to see the difference in frequency and jitter.

2-6.6 MEASURING VOLTAGE IN TIME (STROBING VOLTMETER)

The Delayed Scan mode enables the DTS-2070 to measure the voltage on either channel at a point in time determined by the delay setting programmed into the DTS, with respect to the arming signal referenced. See Figure 2-18 for an example of how to use this mode.

The point where the DTS-2070 strobe digitizes is determined by the position of the arming signal plus the delay programmed into the delay register in menu 13. The user can position the arming edge and/or the delay value to set the point where the DTS strobe digitizes.

Menu 13 on the front panel gives the user the ability to select the STROBE arming INPUT, CHANNEL to be measured and the DELAY with respect to the Arming input selected. By pushing the FUNC key on the front panel while in menu 13, the DTS will measure the voltage point on the channel selected. The voltage is then displayed under VLEVEL.

- | | |
|-----------------|----------------|
| 1. STROBE INPUT | DC or 1 or 2 |
| 2. CHANNEL | 1 or 2 |
| 3. DELAY | 8.50 ns to Max |

“STROBE INPUT” can be either DC, which means a 16 bit A/D converter will measure the average or steady state voltage on the selected channel, or, the user can select Arm 1 or Arm 2 inputs to reference the programmed delay value (see Figure 2-18).

The DTS uses a successive approximation technique in conjunction with the $150\mu\text{V}$ resolution voltage references at the comparator inputs to find the voltage at the input channel at the end of the delay programmed. The minimum delay programmable is 8.500 ns delayed from the selected slope of the Arming input referenced. See the DTS-2070 IEEE-488 Interface Guide for details on the programming and use of the Delayed Scan Mode.

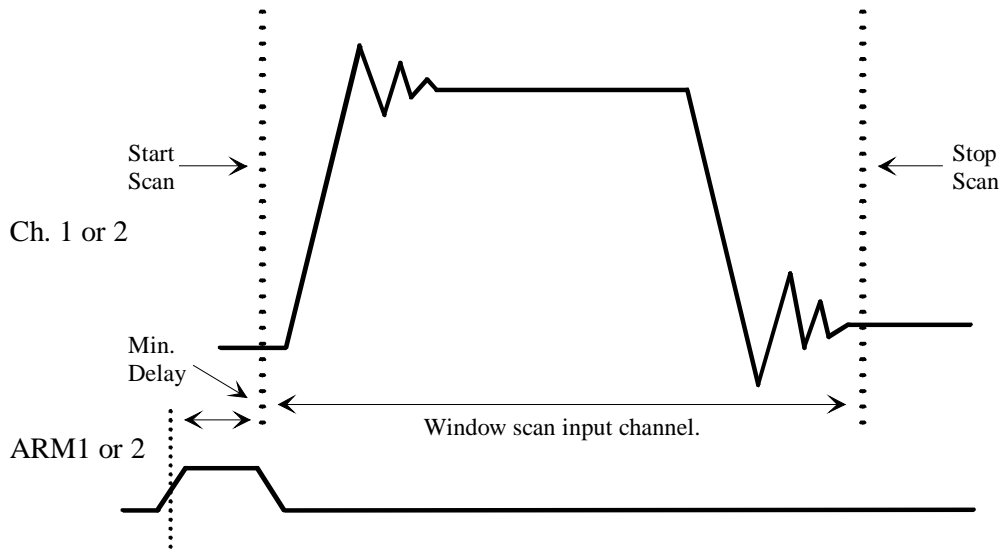

Figure 2-18. Delayed Scan for Measuring Voltage in Time

Over the GPIB, if a “WINDOW” measure is executed, several statistical parameters are available, VAVERAGE, VMINIMUM, VMAXIMUM, VSDEVIATION and VDATA. For example, VDATA is a string of all of the voltage data points taken in the WINDOW search. The user can choose to display these parameters graphically to show the actual waveform on the channel or select one of the other parameters for a quick quantitative analysis.

In Figure 2-18 the signal on either of the DTS channels can be WINDOW scanned and the VDATA read to a PC or workstation and then processed or displayed much as an oscilloscope would. In this case the DTS Arming input selected would operate much like an oscilloscope trigger.

2-7 STATISTICAL CALCULATIONS

The number of individual readings used to produce the statistics is determined by the settings of the sample and set size in menu #4.

2-7.1 SAMPLE SIZE

The usual number of measurements taken is simply the sample size.

In this mode the sets size is one (1) and the sample size is some number between one (1) and one million (1,000,000).

In practice we recommend a sample size somewhere between fifty (50) and five hundred (500). Any fewer than this will not run much faster and little more accuracy is gained with more than this.

Some special cases of sample size settings are:

Filtering - The maximum number of readings that can be filtered is eight thousand (8000). If the sample size is set to greater than 8000 and the filtering is on, the instrument will take only 8000.

Cable Measurement - The minimum sample size of a cable measurement is five hundred (500).

2-7.2 SET SIZE

The set size can be used to measure the standard deviation of a set of measurements.

In this mode the instrument will take a measurement of set size, create statistics, and repeat this the number of sample size times.

An example with a set size of 100 and a sample size of 1000, the instrument would take data from 1000 measurements of size 100. The statistics created and displayed would be generated from the statistics of the 1000 sets of measurements.

This would typically show the standard deviation of a group of measurements over time which would be lower.

2-7.3 STATISTICS

The computation of statistics is straight forward.

Average is the sum of all individual readings divided by the sample size (assuming set size = 1).

Minimum is the algebraically smallest reading.

Maximum is the algebraically largest reading.

\pm Range is the (maximum - minimum/2).

Standard deviation is the squart root of the sum of the squares of the difference between successive individual readings and the average, divided by n-1, where n is the sample size.

The exception to this is when filtering is On. The sample size, for calculation of statistics, is the number of readings within the filter range. The Statistics I menu, #6, indicates the sample completed in the filter range. Pressing the Function button when on the Statistics I menu, #6, will display the unfiltered statistics of the last measurement.

2-8 INSTALLTION AND MAINTENANCE

The DTS is typically installed in a stand alone or benchtop configuration. Optional accessories are available to install the DTS in a rack mount configuration. Installation instructions for rack mounting are included with the rack mounting kits.

2-8.1 INSTALLATION LOCATION

The DTS should be installed in a clean, temperature stable environment. Although the operation temperature ranges is 15°C to 35°C, the ambient temperature must be maintained within $\pm 5^\circ\text{C}$ to stay within calibration specifications.

The DTS should be installed in an area which allows unobstructed air flow of at least two inches on each side for ventilation, and appropriate spacing in the front and back for cable routing.

2-8.2 MOUNTING

In the benchtop installation, the DTS should be mounted on a surface capable of carrying at least 80 pounds. When mounted on a portable cart, such as a scope cart, the DTS can be secured with straps for added safety.

In the rack mount configuration, the DTS feet sit in detents on the mounting shelf preventing the unit from sliding. In addition, mounting brackets allow the DTS to be attached to the 19 inch equipment frame. The weight is carried by the rack mount shelf. (Detailed mounting instructions are provided with the rack mounting kit.)

2-8.3 VENTILATION

To provide adequate ventilation for the DTS, a minimum of two inches of unobstructed air flow must be maintained on each side of the DTS. To maintain the highest accuracy, the DTS air intake should not be near sources that would cause ambient temperature fluctuations. Temperature fluctuations greater than 5°C would require the DTS to be recalibrated.

2-8.4 MAINTAINING PROPER INSTRUMENT GROUNDING

Only the power cords provided with the DTS should be used with the system. Both 120VAC and 230VAC power sources require an earth ground at the power connection. Failure to provide this safety ground could result in improper measurements and/or electrical shock danger to the operator.

Only qualified service personnel should perform maintenance procedures on the DTS. When maintenance is performed, NO protective earth ground connections should be removed.

2-8.5 FUSE REPLACEMENT

The IEC plug-in at the back of the DTS provides the input connection for the AC power cord. A small compartment on the IEC plug houses two 5AT/250V fuses (5x20mm). The manufacturer's part number is Wickmann 19195-063. To gain access to the fuses, remove the power to the DTS and disconnect the power cord. With a small screw driver, pry open the fuse compartment on the IEC plug. Remove the fuses and install the new fuses prior to closing the compartment and reinstalling the power cord.

2-8.6 PREVENTATIVE MAINTENANCE

There are no user required preventative maintenance requirements recommended other than annual calibrations to NIST standards and routine cleaning of the exterior with a clean, damp cloth. Annual calibrations may be performed by a qualified calibration laboratory, or at the WAVECREST factory in Minneapolis, MN.

2-8.7 INTENDED USE OF EQUIPMENT

The DTS unit weight is approximately 50 pounds. To avoid injury or damage to the unit, the DTS should be carried and installed by two people.

The DTS should be used only for its intended purpose as outlined in this manual. To avoid possible injury, the DTS should not be operated with the top cover or other panels removed. Refer installation and maintenance to qualified service personnel.

To avoid explosion, do not operate the DTS in or near an atmosphere of explosive gases

It is essential to maintain the protective earth ground through the grounding connector of the power cord. A loss of the protective ground can cause electrical shock.

TABLE 2 — OPERATOR'S QUICK REFERENCE GUIDE
FRONT PANEL SWITCHES/INDICATORS

<u>Switch/Indicator</u>	<u>Indicator ON</u>	<u>Function</u>
Power ON/OFF	Power ON	Toggles Power On/Off.
INT CAL	Internal Calibrate activated	Automatically calibrates DTS.
EXT CAL	External Calibrate activated	Calibrates/Inputs Deskews.
BURST	Burst mode activated	Takes readings according to the setting of Sample Size display. Then stops.
CONT	Continuous mode activated	Takes readings according to the setting of Sample Size display. Then continues to update readings and display.
MAN	Manual arm activated	Arm the DTS for measuring the next pulse presented.
AUTO	Automatic arm activated	Allows automatic sample collection with arming from a channel input.
EXT	External arm activated	Allows external signal to arm the DTS for measuring the next pulse presented.
MENU SCROLL	Changes menus	Scrolls from menu to menu and field to field inside a menu.
INCREMENT/ DECREMENT	Changes fields	Increase or decrease values in fields or changes options.
GO	Starts DTS	Starts the DTS after required external action taken by user.
FUNCTION	Pulse Finder activated	Activates Pulse Finder when pressed in menu nos. 5,7,8,9. Updates filtered statistics when in menu #6. Execute clear in menu #1. Execute Save/Recall in menu #2. Executes voltage measure in menu #13.

SECTION III - IEEE-488 INTERFACE

3-1 SUMMARY OF DTS-2070 COMMANDS

Diagrams of the syntax defined by IEEE-488.2. This consists of definitions and sub-definitions for a "program message unit".

The commands are organized into 8 different subsystem sets. They are:

System	controls some basic function of the DTS.
Acquire	allows the parameters for acquiring and storing data to be set.
Calibrate	allows the selection of different calibrate functions and retrieves data generated by these functions.
Channel	allows the setting of parameters associated with the different channels.
Display	allows the setting of parameters to control how or what information will be written to screen.
Measure	selects the measurements to be made.
Trigger	controls the trigger modes and parameters for each trigger mode.
Common	the commands defined for all instruments by IEEE-488.2.
Histogram	controls parameters required to produce histograms.
Waveform	provides access to waveform data.

3-2 IEEE-488.1 BUS COMMANDS (HARDWARE)

The following commands are IEEE-488.1 bus commands (hardware line ATN true).

Device Clear	The device clear (DCL) command causes the DTS-2070 to perform a warm boot.
Group Execute	Will cause the same action as the trigger (GET),RUN and *TRIG commands. The DTS-2070 will acquire data.
Clear (IFC) Interface	Halts all bus activity.

3-3 COMMON COMMANDS

The following are common commands defined by IEEE-488.2 and supported by the DTS-2070.

*CLS	Clear Status.
*ESE	Event Status Enable.
*ESE?	Query.
*ESR?	Event Status Register Query.
*IDN?	Identification Query.
*OPC	Operation Complete.
*OPC?	Query.
*RCL <0-10>	Recall.
*RST	Reset. Resets the input and output buffers, resets the parser, and clears any pending commands.
*SAV <0-10>	Save.
*SRE	Service Request Enable.
*SRE?	Query.
*STB?	Status Byte Query.
*TRG	Causes the DTS-2070 to initiate a measurement.
*TST?	Test Instrument Query.

3-4 ROOT COMMANDS

:RUN	Causes the DTS-2070 to initiate measurement. Does the same function as the *TRG.
:TER?	The TER query will read the TRG Event Register to be read. When the register is read it is cleared. A one informs the program that the trigger has occurred. Monitor this bit to know when a takesample (burst), pulse find, cable measure or an internal/external calibration is complete.
:LER?	The LER query will read the Local Event Register. When the query is received and the register is read, it is cleared. A non-zero indicates that a reset is in progress.
:SDS?	The SDS query reads the Special Device Register. When the query is received and the register is read, it is cleared. This register is used to indicate when some commands are complete when they don't set a TRG or MAV bit. Same as bit 3 of a serial poll.

The following is a listing of the commands used to support the DTS-2070 organized by the subsystems listed earlier in this document.

3-5 SYSTEM COMMANDS

:SYSTem:CHANnel<1 2 BOTH>	Set Channel.
:SYSTem:CHANnel?	Read Channel.
:SYSTem:DCCHANnel<1 2>	Select dc measurement channel.
:SYSTem:DCCHANnel?	Read dc selected channel.
:SYSTem:GATing<ON OFF>	Turn gating on or off.
:SYSTem:GATing?	Read gating selection.
:SYSTem:HEADer<OFF ON 0 1>	Select Header Type.
:SYSTem:HEADer?	Read Header Type Selected.
:SYSTem:LONGform<OFF ON 0 1>	Select Long or Short form of Headers.
:SYSTem:LONGform?	Read long or short-form Selected.
:SYSTem:GO	Execute GO button.
:SYSTem:NOGO	Execute GO, but do not perform function.

3-5 SYSTEM COMMANDS (cont)

<code>:SYSTem:ARMinG</trigger source/trigger sequence/start arm /stop arm/arm 1 ref/arm 2 ref/arm 1 slope /arm 2 slope/start count/stop count></code>	Arming macro for speed.
<code>:SYSTem:MACro</function/channel/trigger source/trigger sequence /percent/start reference voltage/stop reference voltage></code>	Macro used for speed.
<code>:SYSTem:TIMEout<value></code>	Timeout on pulse measurement. 10 seconds default. Integer seconds.
<code>:SYSTem:STRObeARM<ARM1 ARM2 DC> :SYSTem:STRObeARM?</code>	Select strobe arming input. Read strobe arming input.
<code>:SYSTem:STRObeCHANnel<1 2> :SYSTem:STRObeCHANnel?</code>	Select strobe input channel. Read strobe channel.
<code>:SYSTem:STRObeDELAy<value> :SYSTem:STRObeDELAy?</code>	Set strobe delay. Read strobe delay.
<code>:SYSTem:STRObeLEVEl</<1 2>/<ARM1 ARM2>/max start delay/ max end delay/max delta/min start delay/ min end delay/min delta></code>	Set delays for strobe pulsefind.
<code>:SYSTem:STRObeSTARt<value> :SYSTem:STRObeSTARt?</code>	Set start delay. Read start delay.
<code>:SYSTem::STRObeSTOP<value> :SYSTem:STRObeSTOP?</code>	Set stop delay. Read stop delay.
<code>:SYSTem:STRObeINC<value> :SYSTem:STRObeINC?</code>	Set stepincrements value. Read stepincrements value.
<code>:SYSTem:STRObe#<value> :SYSTem:STRObe#?</code>	Set number of steps. Read number of steps.
<code>:SYSTem:WINDow</start value/stop value/<step increment #of steps>></code>	Set parameters.
<code>:SYSTem:WAVE<PEAK FLAT STRObe> :SYSTem:WAVE?</code>	Set pulse find to locate peaks or flat spot (usually for a non sinewave). Read type of waveform search to be used by pulse find.

3-6 ACQUIRE COMMANDS

:ACQUIRE:LEVEL	Pulse Finder.
:ACQUIRE:COUNT<value>	Set Sample Size.
:ACQUIRE:COUNT?	Read Sample Size.
:ACQUIRE:COMPLETE?	Number of readings taken.
:ACQUIRE:FUNCTION<TT+ TT- PW+ PW- PERIOD TPD++ TPD- - TPD+- TPD- + FREQ>	Select function.
:ACQUIRE:FUNCTION?	Read function selected.
:ACQUIRE:RUN <TT+ TT- PW+ PW- PERIOD TPD++ TPD- - TPD+- TPD- + FREQ>	Select function and return average and jitter.
:ACQUIRE:ALL <TT+ TT- PW+ PW- PERIOD TPD++ TPD- - TPD+- TPD- + FREQ>	Select function and return all statistics.
:ACQUIRE:MEASURE	Takes a measurement and returns average & standard deviation.
:ACQUIRE:SETS COUNT<value>	Set sets size.
:ACQUIRE:SETS COUNT?	Read sets size.
:ACQUIRE:WINDOW</start value/stop value/<step increment #of points>>	Set parameters and return voltage average.

3-7 CALIBRATE COMMANDS

:CALIBRATE:INTERNAL	Initiate internal calibration.
:CALIBRATE:EXTERNAL	Initiate external calibration.
:CALIBRATE:DATA<block>	Set external calibration values.
:CALIBRATE:DATA?	Read external calibration values.

3-8 CHANNEL COMMANDS

:CHANnel<START STOP>:EXTernalarm<ARM1 ARM2>	Select event external arm.
:CHANnel<START STOP>:EXTernalarm?	Read selected external arm.
:CHANnel<START STOP>:LEVel<value>	Set event trip level.
:CHANnel<START STOP>:LEVel?	Read event level.
:CHANnel<START STOP>:<MIN MAX>?	Read START or STOP min or max peaks.
:CHANnel<START STOP>:COUNT<1 to 256>	Set event arm on Nth count.
:CHANnel<START STOP>:COUNT?	Read event arm on Nth count.

3-9 DISPLAY COMMANDS

:DISPlay:FILTer<ON OFF>	Select filtering on or off.
:DISPlay:FILTer?	Read selected filtering.
:DISPlay:FILTer<MINimum MAXimum><value>	Set filter value.
:DISPlay:FILTer<MINimum MAXimum>?	Read filter value.
:DISPlay:LINE<quoted string>	Display message on screen.
:DISPlay:TEXT BLANK	Clear or restore display.
:DISPlay:STATistics<ON OFF>	Turn update statistics to display on or off.
:DISPlay:STATistics?	Read statistics mode.
:DISPlay:PANel<ON OFF>	Turn front panel on or off.
:DISPlay:PANel?	Read panel mode.
:DISPlay:LEVel<value value>	Set percent.
:DISPlay:LEVel?	Read pulse percent.
:DISPlay:USER<ON OFF>	Selects user reference voltages for current function.
:DISPlay:USER?	Reads current user state.

3-10 MEASURE COMMANDS

:MEASure:AVERage?	Read average.
:MEASure:JITTer?	Read jitter.
:MEASure:SDEViation?	Read standard deviation.
:MEASure:MIN?	Read minimum measured value.
:MEASure:MAX?	Read maximum measured value.
:MEASure:RANGe?	Read range of measured values.
:MEASure:CABLe?	Read cable measured value.
:MEASure:DATA?	Read measurement data.
:MEASure:DCvlevel?	Read dc level.
:MEASure:STRObevlevel?	Read strobed voltage level.
:MEASure:VMAXimum?	Read strobed maximum voltage.
:MEASure:VMINimum?	Read strobed minimum voltage.
:MEASure:VSDEViation?	Read voltage standard deviation.
:MEASure:VDATA?	Return strobed measured points.
:MEASure:WINDow?	Return average strobed voltage.

3-11 TRIGGER COMMANDS

:TRIGger:SOURce<EXTernal AUTomatic MANuel>	Selects trigger source.
:TRIGger:SOURce?	Read trigger source.
:TRIGger:SEQuence<STARt STOP STARTFIRST STOPFIRST>	Selects trigger sequence.
:TRIGger:SEQuence?	Reads trigger sequence.
:TRIGger:LEVel<ARM1 <ARM2 GATe>><value>	Set trigger level.
:TRIGger:LEVel<ARM1 <ARM2 GATe>>?	Read trigger level setting.
:TRIGger:SLOPe<ARM1 <ARM2 GATe>><POS NEG RISe FALl>	Set arming direction.
:TRIGger:SLOPe<ARM1 <ARM2 GATe>>?	Read arming direction.
:TRIGger:<MAX MIN?><ARM1 ARM2>	Read arming peaks.

This page intentionally left blank.

WAVECREST CORPORATION

World Headquarters:

7626 Golden Triangle Drive
Eden Prairie, MN 55344
(952) 831-0030
FAX: (952) 831-4474
Toll Free: 1-800-733-7128
www.wavecrest.com

West Coast Office:

1735 Technology Drive, Ste. 400
San Jose, CA 95110
(408) 436-9000
FAX: (408) 436-9001
1-800-821-2272

Europe Office:

Lilienthalalle 25
D-80939 Munchen
011-49-89-32225330
FAX: 011-49-89-32225333

Japan Office:

2-1 Ohtemachi 2-Chome
Chyoda-Ku, Tokyo 100-0004, Japan
81-3-5960-5770